

# MEGApix® CaaS™ 4MP Long Range Bullet Camera

DWC-MB44Wi650C6 - 64GB storage

DWC-MB44Wi650C1 - 128GB storage

DWC-MB44Wi650C2 - 256GB storage

DWC-MB44Wi650C5 - 512GB storage

DWC-MB44Wi650C1T - 1TB storage



## *User's Manual* Ver. 04/22

Before installing and using the camera, please read this manual carefully.  
Be sure to keep it handy for future reference.

# Safety Information

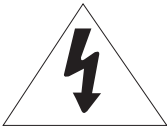

## CAUTION

RISK OF ELECTRIC SHOCK.  
DO NOT OPEN.



## CAUTION:

TO REDUCE THE RISK OF ELECTRIC SHOCK, DO NOT REMOVE COVER (OR BACK) NO USER SERVICEABLE PARTS INSIDE. REFER SERVICING TO QUALIFIED SERVICE PERSONNEL.



### Warning

This symbol indicates that dangerous voltage consisting a risk of electric shock is present within this unit.



### Precaution

This exclamation point symbol is intended to alert the user to the presence of important operating and maintenance (servicing) instructions in the literature accompanying the appliance.

## WARNING

To prevent damage which may result in fire or electric shock hazard, do not expose this appliance to rain or moisture.

## WARNING

1. Be sure to use only the standard adapter that is specified in the specification sheet. Using any other adapter could cause fire, electrical shock, or damage to the product
2. Incorrectly connecting the power supply or replacing battery may cause explosion, fire, electric shock, or damage to the product.
3. Do not connect multiple cameras to a single adapter. Exceeding the capacity may cause excessive heat generation or fire
4. Securely plug the power cord into the power receptacle. Insecure connection may cause fire
5. When installing the camera, fasten it securely and firmly. A falling camera may cause personal injury.
6. Do not place conductive objects (e.g. screw drivers, coins, metal items, etc.) or containers filled with water on top of the camera. Doing so may cause personal injury due to fire electric shock, or falling objects.
7. Do not install the unit in humid, dusty, or sooty locations. Doing so may cause fire or electric shock
8. If any unusual smells or smoke come from the unit, stop using the product. Immediately disconnect the power source and contact the service center. Continued use in such a condition may cause fire or electric shock
9. If this product fails to operate normally, contact the nearest service center. Never disassemble or modify this product in any way.
10. When cleaning, do not spray water directly onto parts of the product. Doing so may cause fire or electric shock

## Precaution

### Operating

- Before using, make sure power supply and all other parts are properly connected.
- While operating, if any abnormal condition or malfunction is observed, stop using the camera immediately and contact your dealer.

### Handling

- Do not disassemble or tamper with parts inside the camera.
- Do not drop the camera or subject it to shock or vibration as this can damage the camera.
- Clean the clear dome cover with extra care. Scratches and dust can ruin the quality of the camera image.

### Installation and Storage

- Do not install the camera in areas of extreme temperature, exceeding the allowed range.
- Avoid installing in humid or dusty environments.
- Avoid installing in places where radiation is present.
- Avoid installing in places where there are strong magnetic fields and electric signals.
- Avoid installing in places where the camera would be subject to strong vibrations.
- Never expose the camera to rain or water.

# Important Safety Instructions

1. **Read these instructions.** - All safety and operating instructions should be read before installation or operation.
2. **Keep these instructions.** - The safety, operating and use instructions should be retained for future reference.
3. **Heed all warnings.** - All warnings on the product and in the operating instructions should be adhered to.
4. **Follow all instructions.** - All operating and use instructions should be followed.
5. **Do not use this device near water.** - For example: near a bath tub, wash bowl, kitchen sink, laundry tub, in a wet basement; near a swimming pool; etc.
6. **Clean only with dry cloth.** - Unplug this product from the wall outlet before cleaning. Do not use liquid cleaners.
7. **Do not block any ventilation openings. Install in accordance with the manufacturer's instructions.** - Slots and openings in the cabinet are provided for ventilation, to ensure reliable operation of the product, and to protect it from over-heating. The openings should never be blocked by placing the product on bed, sofa, rug or other similar surfaces. This product should not be placed in a built-in installation such as a bookcase or rack unless proper ventilation is provided and the manufacturer's instructions have been adhere to.
8. **Do not install near any heat sources such as radiators, heat registers, or other apparatus (including amplifiers) that produce heat.**
9. **Do not defeat the safety purpose of the polarized or grounding-type plug.** A polarized plug has two blades with one wider than the other. A grounding type plug has two blades and a third grounding prong. The wide blade or the third prong are provided for your safety. If the provided plug does not fit into your outlet, consult an electrician for replacement.
10. **Protect the power cord from being walked on or pinched particularly at plugs, convenience receptacles, and the point where they exit from the apparatus.**
11. **Only use attachments/accessories specified by the manufacturer.**
12. **Use only with cart, stand, tripod, bracket, or table specified by the manufacturer, or sold with the apparatus. When a cart is used, use caution when moving the cart/apparatus combination to avoid injury from tip-over.**
13. **Unplug the apparatus during lightning storms or when unused for long periods of time.**
14. **Refer all servicing to qualified service personnel. Servicing is required when the apparatus has been damaged in any way, such as power supply cord or plug is damaged, liquid has been spilled or objects have fallen into the apparatus, the apparatus has been exposed to rain or moisture, does not operate normally, or has been dropped.**



## Disposal of Old Appliances

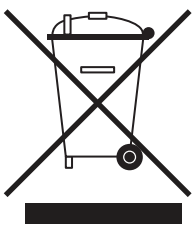

1. When this crossed-out wheel bin symbol is attached to a product it means the product is covered by the European Directive 2002/96/EC.
2. All electrical and electronic products should be disposed of separately from the municipal waste stream in accordance to laws designated by the government or the local authorities.
3. The correct disposal of your old appliance will help prevent potential negative consequences for the environment and human health.
4. For more detailed information about disposal of your old appliance, please contact your city office, waste disposal service or the shop where you purchased the product.



This equipment has been tested and found to comply with the limits for a Class A digital device, pursuant to part 15 of the FCC Rules.

These limits are designed to provide reasonable protection against harmful interference when the equipment is operated in a commercial environment.

This equipment generates, uses, and can radiate radio frequency energy and, if not installed and used in accordance with the instruction manual, may cause harmful interference to radio communications. Operation of this equipment in a residential area is likely to cause harmful interference in which case the user will be required to correct the interference at his own expense.

# Table of Contents

---

## **Introduction**

Product & Accessories.....	4
Parts Name.....	5

## **Installation**

Disassembling the Camera.....	6
Installation.....	6
Factory Reset.....	6
Cabling.....	7
SD Memory Card.....	9

## **Network Setup**

DW IP Finder.....	10
-------------------	----

## **Web Viewer**

GUI Overview.....	11
-------------------	----

## **Camera Settings**

Setup > Video & Audio Setup > Video Configuration.....	12
Setup > Video & Audio > OSD Configuration.....	16
Setup > Video & Audio > Region of Interest Configuration .....	17
Setup > Video & Audio > Privacy Mask Configuration.....	18
Setup > Camera > Camera Image adjustment and Enhancement.....	19
Setup > Camera > Video Enhancement.....	25
Setup > Network Settings.....	27
Setup > Trigger Action.....	36
Setup > Events Setup.....	39
Setup > Edge Setup.....	43
Setup > Security.....	46
Setup > System > System Information.....	53
Setup > System > Firmware Update.....	54
Setup > System > Date & Time.....	56
Setup > System > User Management.....	57
Setup > System > System Log.....	58
Setup > System > Factory Reset.....	59
Setup > System > Restart.....	60
Network Connection .....	61
DDNS Registration.....	62
Network Environments.....	63
Port Forwarding.....	66
Starting the IP Camera.....	67

<b>Appendix.....</b>	<b>68</b>
<b>FAQs.....</b>	<b>68</b>
<b>Dimensions.....</b>	<b>69</b>
<b>Warranty.....</b>	<b>70</b>
<b>Limits &amp; Exclusions.....</b>	<b>71</b>

# Introduction - Product & Accessories

⊠ Please check if all the camera and accessories are included in the package.

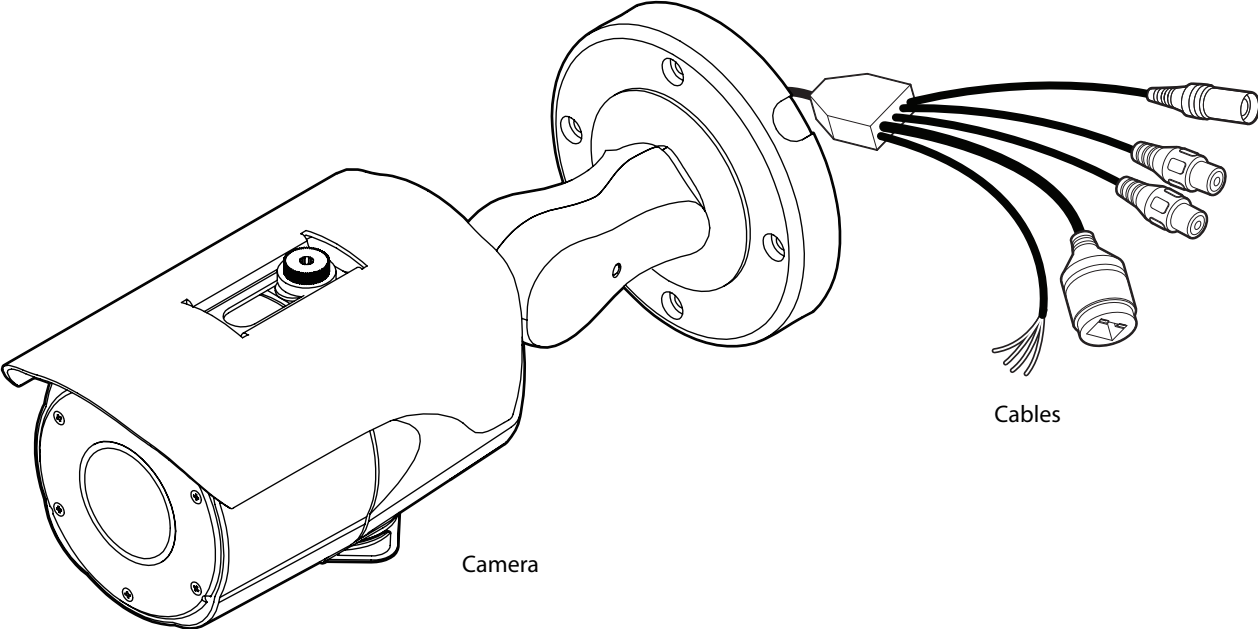

Hex Allen wrench



Test video cable



DC plug cable

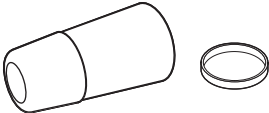

Waterproof cap and gasket

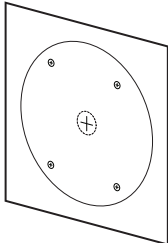

Mounting template

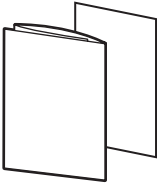

Quick setup guide

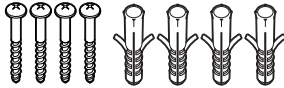

Screws and plastic anchors-4pcs

# Introduction - Part Name

---

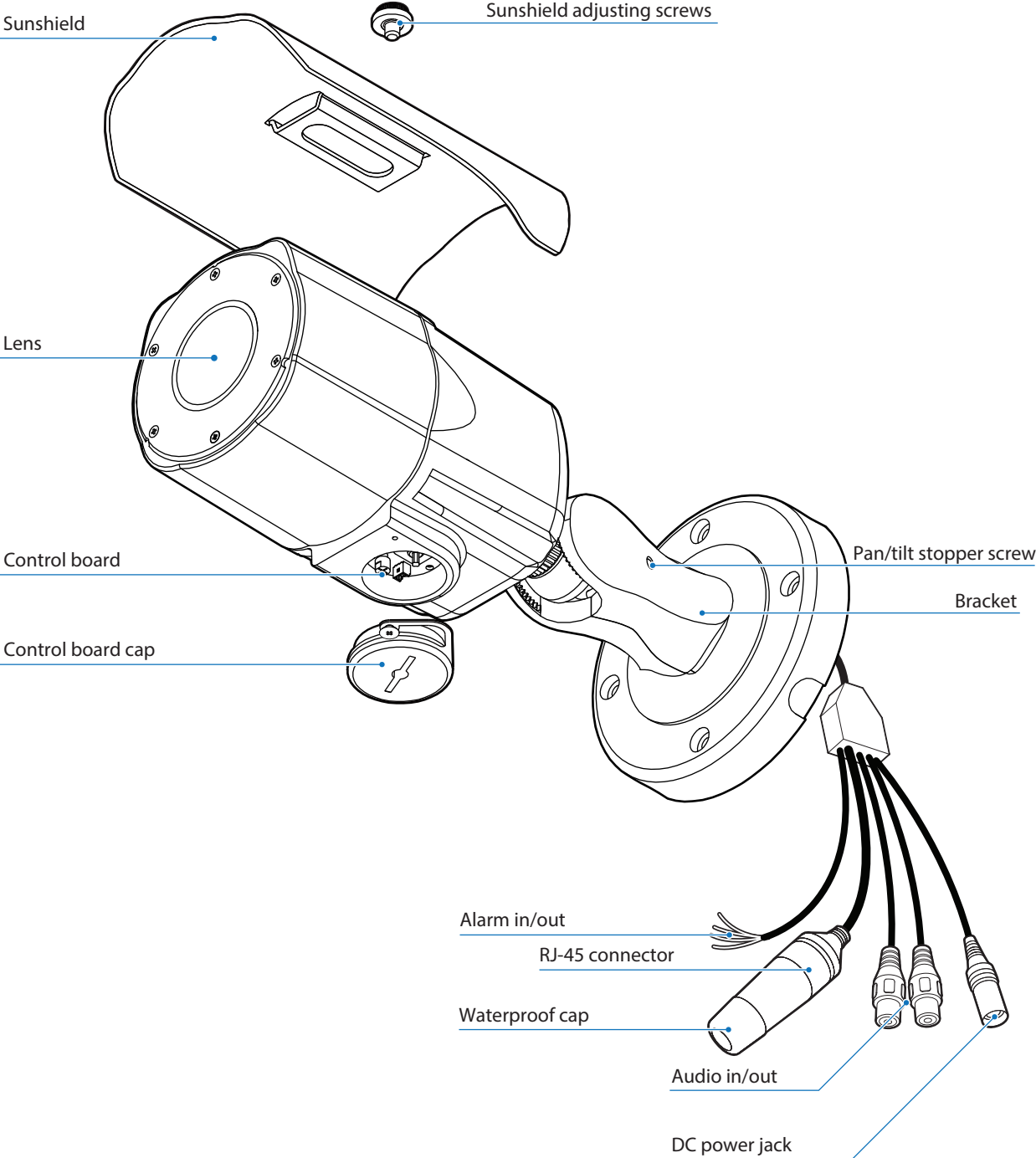

# Installation - Installation

Before installing your camera, you have to read the following cautions.

1. You have to check whether the location can bear five times of the weight of your camera.
2. Don't let the cable to be caught in improper place or the electric line cover to be damaged. Otherwise it may cause a breakdown or fire.
3. When installing your camera, don't allow any person to approach the installation site. If you have any valuable things under the place, move them away.

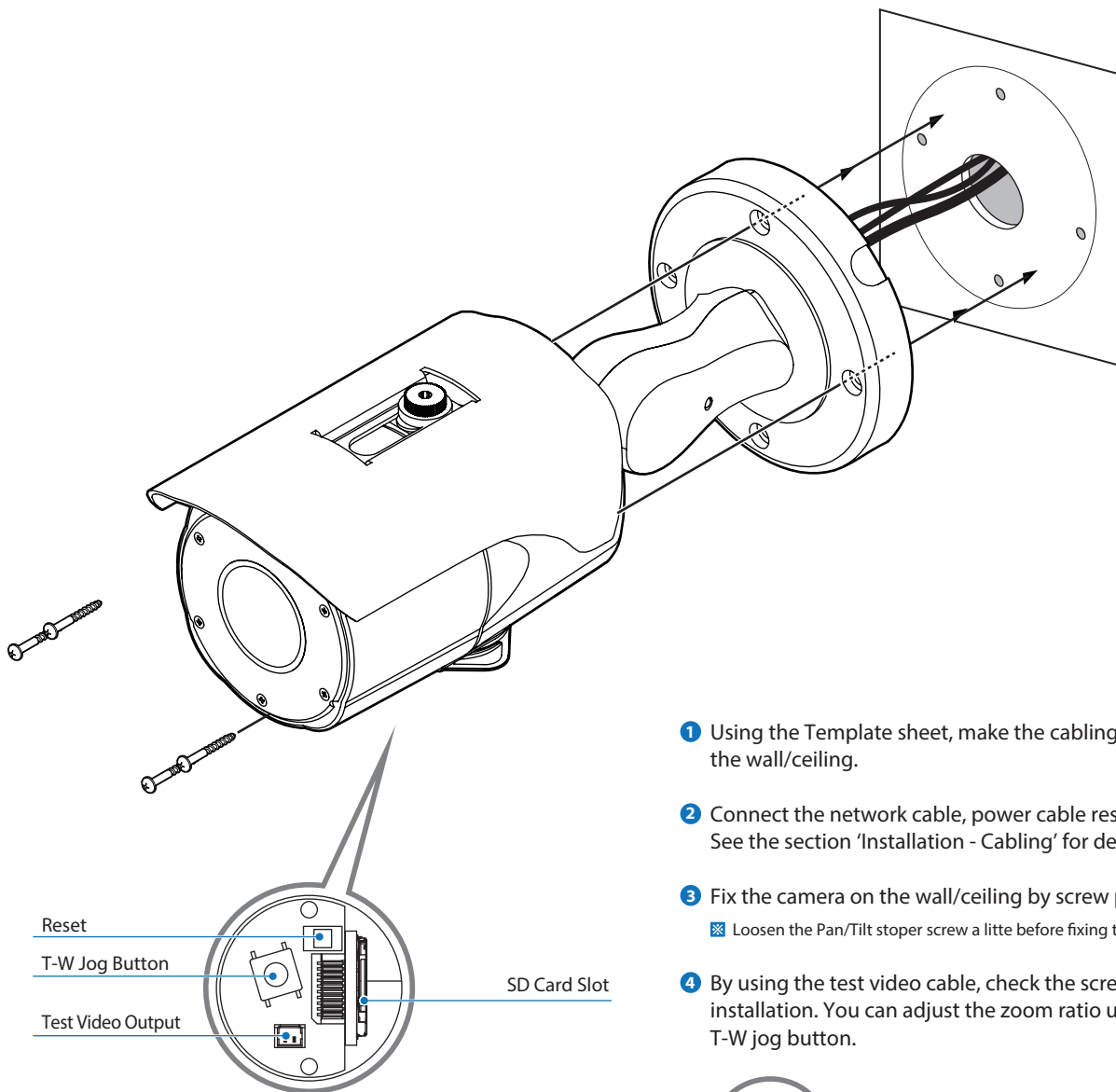

- 1 Using the Template sheet, make the cabling hole on the wall/ceiling.
- 2 Connect the network cable, power cable respectively. See the section 'Installation - Cabling' for details.
- 3 Fix the camera on the wall/ceiling by screw provided.
  - ⊠ Loosen the Pan/Tilt stopper screw a little before fixing the camera.
- 4 By using the test video cable, check the screen during installation. You can adjust the zoom ratio using the T-W jog button.

## ⊠ Reset to the Factory Default

Press the reset button for 5 seconds to return the setup to the factory default.

## ⊠ Warning

If you press the 'Reset' button, you will lose all setting data. If needed, please, make a note for further installation.

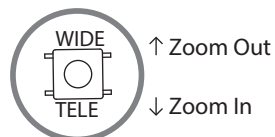

# Installation - Cabling

---

### Two Options

Use a PoE-enabled switch to connect data and power through a single cable and begin viewing and recording images instantly. A non-PoE switch will require an adaptor for power transmission.

- 1. Using a PoE Switch or PoE Injector  
The Camera is PoE-compliant, allowing transmission of power and data via a single Ethernet cable. PoE eliminates the need for the different cables used to power, record, or control the camera. Follow the illustration below to connect the camera to a PoE-enabled switch using an Ethernet cable.

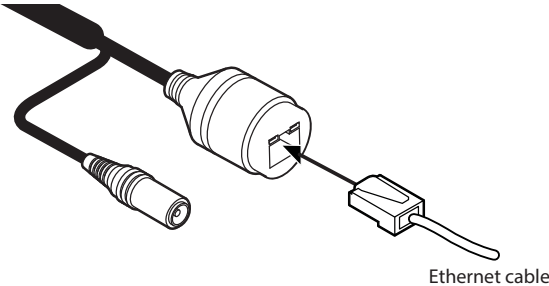

- 2. Not using PoE Switch or PoE Injector  
If a PoE-enabled switch is not used, use a power adaptor for power transmission and non-PoE switch for data transmission. Follow the illustrations below to connect the camera without a PoE-enabled Switch.

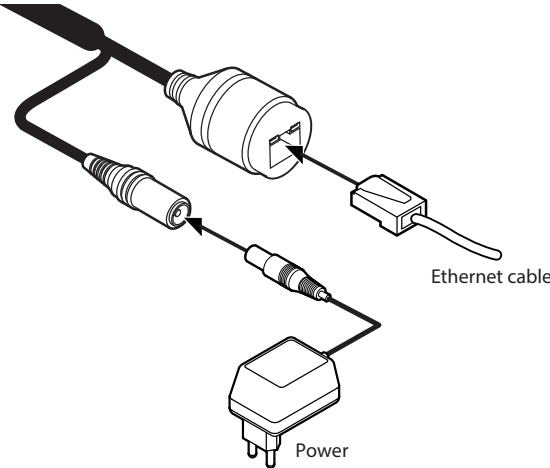



# Installation - Cabling

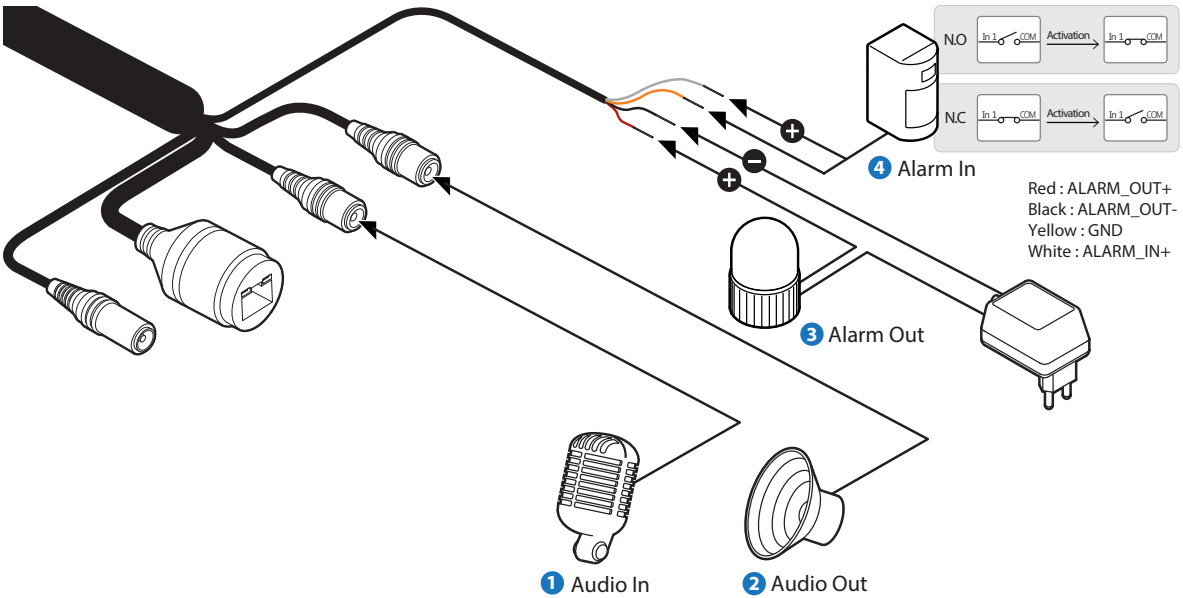

## 1 Audio In

Cable of the sensor/alarm input device should connect to alarm in+ and alarm in- of the cable slot.

## 2 Audio Out

It connects to the alarm lights, siren or lamps and the sensor types are normal open and normal close. Cable of the alarm output device should connect to alarm out+ and alarm out- of the cable slot.

⊠ If the speaker without the amplifier is connected to Audio Out port, it doesn't work properly. Therefore, the speaker with the amplifier or the separate amplifier is needed.

## 3 Alarm Out

It connects to the alarm lights, siren or lamps and the sensor types are normal open and normal close. Alarm & light bar + need to be connected with power + or adaptor +. Alarm out+ need to be connected with Alarm - or light bar -. Alarm out- need to be connected with power - or adaptor -.

## 4 Alarm In

Cable of the sensor/alarm input device should connect to white and yellow line of the Alarm cable.

# Installation - Inserting/Removing SD Memory Card

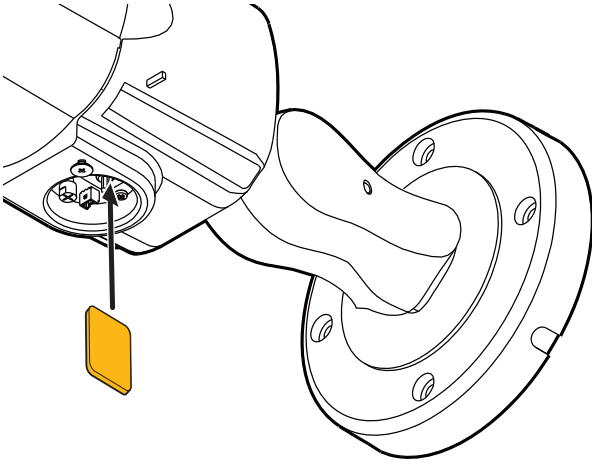

The memory card is an external data storage device that has been developed to offer an entirely new way to record and share video, audio, and text data using digital devices.

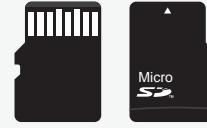

#### ※ Recommended SD Card Specification (Not Included)

- Type: Micro SD (SD/SDHC/SDXC)
- Manufacturer: Transcend, Kingston, Toshiba, SanDisk
- Capacity: 4GB~128GB
- Class: over UHS-I U3 Class 10

#### 1 Inserting an SD Memory Card

Insert the SD card in the arrow direction.

- ※ Don't insert the SD memory card while it's upside down by force. Otherwise, it may damage the SD memory card.
- ※ Use the tweezers when inserting or picking out the SD card.

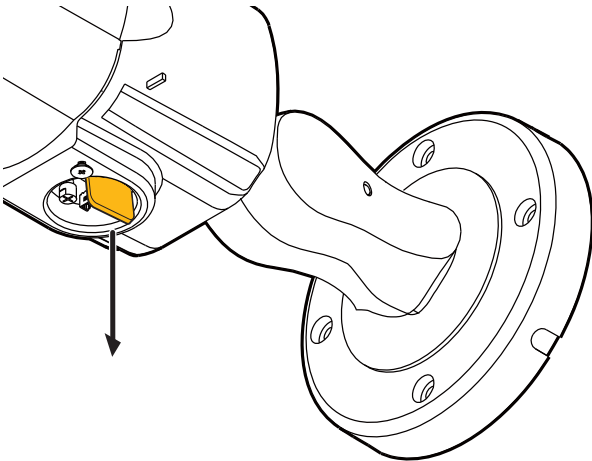

#### 2 Removing an SD Memory Card

Removing an SD Memory Card Gently press down on the exposed end of the memory card as shown in the diagram to eject the memory card from the slot.

- ※ Pressing too hard on the SD memory card can cause the card to shoot out uncontrollably from the slot when released.
- ※ If you have saved data in the SD memory card, removing the SD memory card prior to setting record to OFF will cause damage to the data stored in the card.

# Network Setup - DW IP Finder™

The screenshot shows the DW IP Finder interface. On the left, there is a sidebar with several controls: 'Thumbnail view', 'Select network to scan' (set to 'Local Area Connection [192.168.0.188]'), 'Filter results' (set to 'All'), 'Scan network' (with a 'Scan Devices' button), 'Show/hide thumbnail view' (with a 'Thumbnail' checkbox), 'Refresh thumbnail view' (with a 'Refresh Thumbnail' button), 'Bulk IP assignment' (with a 'Bulk IP Assignment' button), 'Bulk password assignment' (with a 'Bulk Password Assignment' button), and 'Firmware upgrade' (with a 'FW Upgrade' button). At the bottom of the sidebar, there is a 'Selected camera's username and password' section with 'Username' and 'Password' fields and a 'Log In' button.

The main area displays a table of detected cameras. The table has columns for 'Name', 'IP Address', 'Model', 'MAC Address', 'Netmask', 'Gateway', 'Port', 'DHCP', 'Version', 'Ping Test', 'IP Conf.', and 'Uptime'. Below the table, there are thumbnail images of cameras and buttons for 'Ping' and 'Click' for each row. On the right side of the interface, there are labels pointing to specific elements: 'Firmware version' (points to the 'Version' column), 'Camera's uptime' (points to the 'Uptime' column), 'Open IP configuration settings' (points to the 'Click' button), 'Ping camera' (points to the 'Ping' button), 'Camera's network information' (points to the 'IP Address', 'Netmask', 'Gateway', and 'Port' columns), and 'Camera's name, IP and MAC addresses' (points to the 'Name', 'IP Address', and 'MAC Address' columns).

- 1 To install the DW IP Finder, go to: <http://www.digital-watchdog.com>
- 2 Enter "DW IP Finder" on the search box at the top of the page.
- 3 Go to the "Software" tab on the DW IP Finder page to download the installation file.
- 4 Follow the installation to install the DW IP Finder. Open the DW IP Finder and click 'Scan Devices'. It will scan the selected network for all supported devices and list the results in the table. During the scan, the DW® logo will turn gray.
- 5 When connecting to the camera for the first time, a password must be set. To set up a password for your camera:

- a. Check the box next to the camera in the IP Finder's search results. You can select multiple cameras.
- b. Click "Bulk Password Assign" on the left.
- c. Enter admin/admin for the current username and password. Enter a new username and password to the right.

The 'Bulk Password Assignment' dialog box has two sections. The 'Current Account' section has fields for 'Username' (containing 'admin') and 'Password' (containing 'admin'). The 'New Password' section has fields for 'New', 'Confirm', and 'Hint'. A 'Change' button is located below these fields. Below the sections is a table with columns 'Name', 'MAC Address', 'IP Address', and 'Note'. One row is visible with the name 'DWC-M2WAT', MAC address '00:0D:F1:21:66:92', and IP address '192.168.10.159'.

Passwords must have a minimum of 8 characters with at least 4 combinations of uppercase letters, lowercase letters, numbers and special characters. Passwords cannot contain the user ID.

- d. Click "change" to apply all changes.

- 6 Select a camera from the list by double-clicking on the camera's image or clicking on the 'Click' button under the IP Conf. column. The pop-up window will show the camera's current network settings, allowing admin users to adjust the settings as needed.
- 7 To access the camera's web page, click on the 'View Camera Website' from the IP Config window.
- 8 To save changes made to the camera's setting, enter the username and password of the camera's admin account and click 'Apply'.

The 'DW Camera Settings' dialog box shows configuration options for a camera. Fields include 'Camera Name' (DWC-MD421TIR) and 'MAC Address' (00:0D:F1:20:A4:9E). Under 'IP Configuration Mode', 'DHCP' is selected. Other fields include 'IP Address' (192.168.1.101), 'Netmask' (255.255.255.0), 'Gateway' (192.168.1.1), and 'DNS' (192.168.40.1). The 'Ports' section has fields for 'Web Port' (80), 'Control Port' (0), 'Video Port' (0), 'Audio Transmit' (0), and 'Audio Receive' (0). At the bottom, there are fields for 'Username' (admin) and 'Password' (masked with dots). Buttons include 'Restore default camera configuration', 'View Camera Website', 'Apply', 'Reboot', and 'Cancel'.

# Web Viewer Screen - Basic Screen

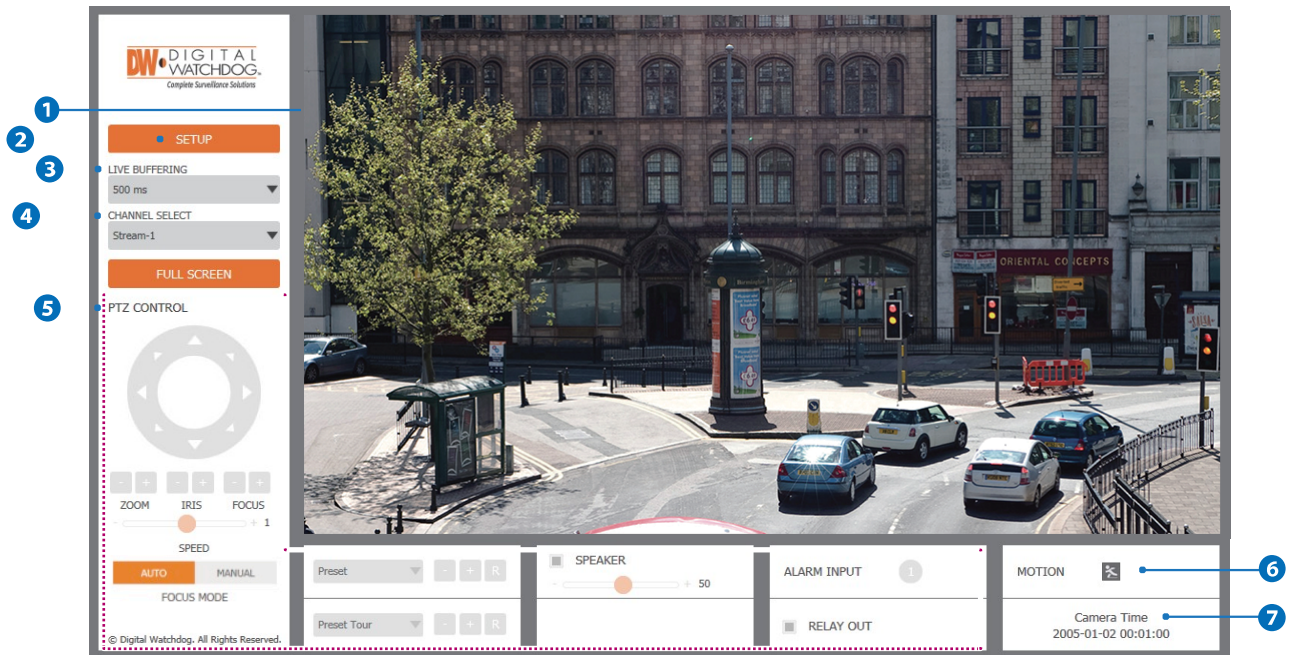

⊗ Web viewer is optimized with explorer10 or above version and Firefox.

⊗ If VLC is not installed or VLC plugin is not supported (Chrome), Live buffering and Channel select menu on 3, 4 will be changed to Live Viewer menu, and then if HTML5(MJPEG) is selected on Live Viewer menu, then you can check the video.

- 1 Live video display. This is the region for live video stream from the camera.
- 2 Setup popup button. Click it to open the Setup page to setup details of IP camera like Video, Network, Events, System and etc. See the section 'Setup' .
- 3 When the image goes unsmoothly because of bad network connection, it stored image during setup time and shows the image on the live view screen.
  - ⊗ User will see the delayed images as much as setup time.
- 4 Channel Select button. Select a stream produced from the camera between Stream 1 ~ 3 to display it in the live view screen.
  - ⊗ Refer the 'Setup > Video & Audio > Video' to setup the Video Stream.
- 5 Below "Menu" is supported in accordance with models.
 

---

**PTZ Control** - Depending on the product model, zoom and focus may not be available.

---

**Preset** - Does not support.

---

**Speaker Control** - Does not support.

---

**Alarm Input** - Does not support.

---

**Relay Out** - Does not support.

---
- 6 **Motion** - It shows the Motion event status.
  - ⊗ Event Alert Icon (  ) appears if 'Motion Detection' is activated.
- 7 **Camera Time** - Display the camera time.

# Setup - Video & Audio Setup

## Video Configuration

**1**

**2**

**VIDEO CONFIGURATION**

Stream	Codec	Description
1	H.264	channel1
2	H.264	channel2
3	M-JPEG	channel3

**Codec**

Codec: H.264

Description: channel1

Resolution: 2560x1440

Frame Rate(FPS): 30

GOP: 30 [ 1 ~ 120 ]

Profile: High

Smart Bitrate Control: Off

Bitrate Mode: CBR

Target Bitrate: 5866 [ 100Kbps ~ 10Mbps ]

Extension Option: Off

Quality: 5 [ 1 ~ 10 ]

**APPLY**

© Digital Watchdog. All Rights Reserved.

**1 Detail Page** - When you select an item from the menu, you can set the details for the selected item.

### **2 Setup Constitution**

#### **Video&Audio**

[ VIDEO, OSD, ROI, PRIVACY MASK ]

#### **Camera**

[ IMAGE ADJUSTMENT, EXPOSURE, DAY&NIGHT, BACKLIGHT, WHITE BALANCE, IMAGE, VIDEO ]

#### **Network**

[ STATUS, NETWORK SETTING, AUTO IP, ONVIF, UPNP, DDNS, FTP, SMTP, SNMP, RTSP INFORMATION ]

#### **Trigger Action**

[ ACTION RULES, IMAGE TRANSFER ]

#### **Events**

[ EVENT RULES, MOTION, TEMPERATURE ]

#### **Edge**

[ SPECTRUM EDGE, STORAGE ]

#### **Security**

[ IP ADDRESS FILTER, RTSP AUTHENTICATION, IEEE 802.1x, HTTPS, CERTIFICATES, SERVICE ]

#### **System**

[ INFORMATION, FIRMWARE UPDATE, DATE&TIME, USER MANAGEMENT, LOG, FACTORY RESET, RESTART ]

# Setup - Video & Audio Setup

## Video Configuration

### VIDEO CONFIGURATION

Stream	Codec	Description
<input checked="" type="radio"/> 1	H.264	channel1
<input type="radio"/> 2	H.264	channel2
<input type="radio"/> 3	M-JPEG	channel3

#### Codec

Codec:

Description:

Resolution:

Frame Rate(FPS):

GOP:  [ 1 ~ 120 ]

Profile:

Smart Bitrate Control:

Bitrate Mode:

Target Bitrate:  [ 100Kbps ~ 10Mbps ]

Extension Option:

Quality:  [ 1 ~ 10 ]

- 1
- 2
- 3
- 4
- 5

- 1 **Live Video Channel Setup** - The video can be configured to variety settings with a combination of codec and resolution. The camera performance has to be considered when setting multiple channels. This effects on the performance of the camera.
- 2 **Codec** - Choose the video codec. According to the selected codec, the subcategories can be changed automatically.
- 3 **Description** - Input the additional description about the selected channel. Max. 30 alphabets are allowed(Including space). For the description, English Alphabets, numbers and special characters ( - \_ @ . ) can be used.
- 4 **Resolution** - Select the video resolution.
  - ⊠ Available resolution can be depends on the codec setup between the channels.

	4M	3M	1080p/i	720p/i	SVGA	VGA	4CIF	CIF
NTSC	2560 x 1440	2304 x 1296	1920 x 1080	1280 x 720	800 x 600	640 x 480	704 x 576 704 x 480	352 x 288 352 x 240
PAL	2560 x 1440	2304 x 1296	1920 x 1080	1280 x 720	800 x 600	640 x 480	704 x 576 704 x 480	352 x 288 352 x 240

<Resolution of Video Format>

- 5 **Frame Rate** - Select the maximum Frame Rate.
  - ⊠ Available Frame Rate can be different although same codecs were set up.

# Setup - Video & Audio Setup

## Video Configuration

### VIDEO CONFIGURATION

Stream	Codec	Description
<input checked="" type="radio"/> 1	H.264	channel1
<input type="radio"/> 2	H.264	channel2
<input type="radio"/> 3	M-JPEG	channel3

#### Codec

Codec:

Description:

Resolution:

Frame Rate(FPS):

GOP:  [ 1 ~ 120 ]

Profile:

Smart Bitrate Control:

Bitrate Mode:

Target Bitrate:  [ 100Kbps ~ 10Mbps ]

Extension Option:

Quality:  [ 1 ~ 10 ]

6  
7  
8

**6 GOP(Group of Pictures) Size** - Set up the number of frames (P-frame) which contain only changed information based on basic frame (I-frame). Regarding videos with lots of movement, if you set GOP size bigger, only the number of P-frames is bigger. As a result, video resolution will be low but 'File size' and 'Bit-rate can be decreased.

**⊗ GOP(Group of Pictures) Size is..**

I-frame and P-frame can be created for MPEG4 and H.264 video compression. I-frame(=key-frame) means the whole image data for one specific scene of video. P-frame is image data which has been changed information compared to I-frame GOP is made up of one I-frame and corresponding several P-frames. To improve video quality, set the number of P-frames smaller and to decrease image size, set the number of P-frames bigger.

**7 Profile** - The profile defines the subset of bit stream features in an H.264 stream, including color reproduction and additional video compression.

**Baseline** - A simple profile with a low compression ratio. The Baseline profile supports I-frames and P-frames.

**Main** - An intermediate profile with a medium compression ratio. The main profile supports I-frames, P-frames, and B-frames.

**High** - A complex profile with a high compression ratio. The high profile supports I-frames, P-frames, and B-frames.

**8 Smart Bitrate Control**

**Off** - You can not use the Smart Bitrate Control function.

**CVBR (Framerate priority)** - This Mode is for cameras which do not want absolute any frame drop, but still want to get lower bitrate. It has limitation when the Target bitrate is set to be very low, but actual motion is big or scene is very noisy.

**CVBR (Quality priority)** - When the Target bitrate is set to very low, and motion is big, then LBR will try to drop frames, and make the final fps to be lower, so that it can save its and make the output frames to have better quality.

**CBR** - This Mode is a CBR alike mode which is close to traditional security IPCAM, and it's not designed for LBR, It's provided as an option in LBR library just to help comparison.

# Setup - Video & Audio Setup

## Video Configuration

### VIDEO CONFIGURATION

Stream	Codec	Description
<input checked="" type="radio"/> 1	H.264	channel1
<input type="radio"/> 2	H.264	channel2
<input type="radio"/> 3	M-JPEG	channel3

#### Codec

Codec:

Description:

Resolution:

Frame Rate(FPS):

GOP:  [ 1 ~ 120 ]

Profile:

Smart Bitrate Control:

Bitrate Mode:  •

Target Bitrate:  [ 100Kbps ~ 10Mbps ] •

Extension Option:  •

Quality:  [ 1 ~ 10 ] •

**9 Bitrate Mode** - Select the bitrate control scheme of video compression from CBR (Constant Bit Rate) or VBR (Variable Bit Rate).

**CBR** - To guarantee the designated constant bit rate, the quality of video are controlled in this mode. Therefore, the quality of video is likely to be varying when network traffic is changing.

**VBR** - To guarantee the designated quality, the bit rate of video stream is changed in this mode. Therefore, the frame rate of video is likely to be varying when network traffic is changing.

This category won't be appear if you select the codec.

**10 Target Bitrate** - If Bitrate Control is set to be CBR, you can set the Target Bitrate.

**11 Extension Option**

**Off** - You can not use the Extension Option.

**SVC-T On** - The H.264 SVC (Scalable Video Coding) is a video compression algorithm that enables effective and efficient transmission of video files over low bandwidth networks.

**12 Quality** - For VBR control mode, The Target Quality of video can be setup.

**13** Click 'Apply' to make above setting effective.



# Setup - Video & Audio Setup

## OSD Configuration

---

The screenshot shows the 'ON SCREEN DISPLAY(OSD) CONFIGURATION' window. It is divided into two main sections: 'Date & Time' and 'User Text'. Each section has a radio button to toggle between 'Off' and 'On'. Below the toggle are two input fields for 'Position X' and 'Position Y', both with a range of '[ 0 ~ 100 ]'. The 'User Text' section also includes a text input field. At the bottom center of the window is an orange 'APPLY' button. Three blue callout circles with numbers 1, 2, and 3 are present. Callout 1 points to the 'Date & Time' section, callout 2 points to the 'User Text' section, and callout 3 points to the 'APPLY' button.

- 1 **Date / Time** - Display the current time.
- 2 **User Text** - Output the TEXT entered by the user. Support a maximum of 30 characters.
- 3 Click 'Apply' to make above setting effective.

# Setup - Video & Audio Setup

## Region of Interest Configuration

---

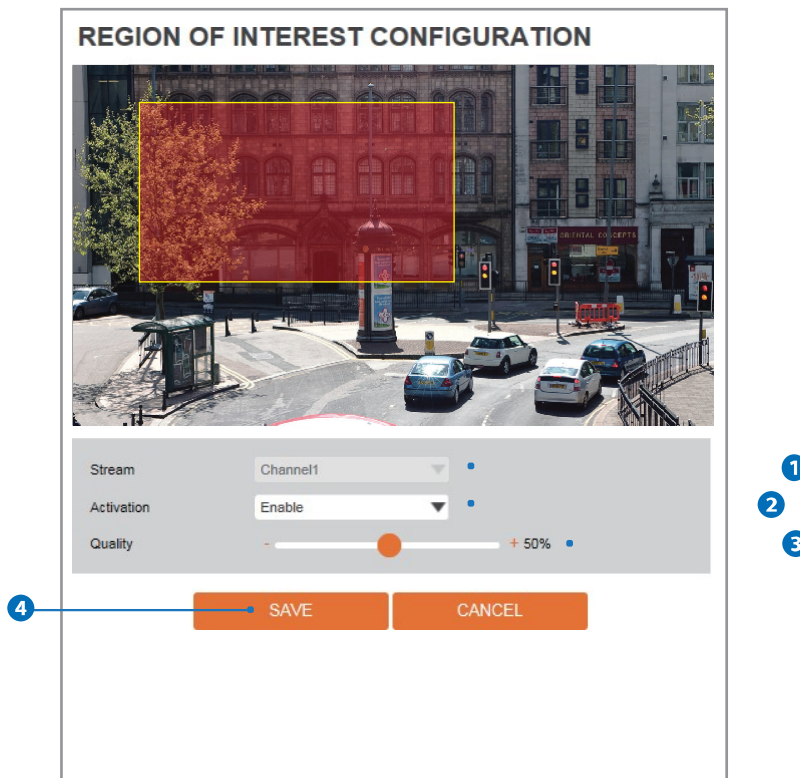

Region of interest function gives much more efficiency picture quality for indicated area to improve picture qualities of movement scene at the same bandwidth.

- 1 Stream** - Select the Stream.
  - ☒ Currently it supports only Channel1.
- 2 Activation** - The Region of interest can be enable or disable.
- 3 Quality** - Set the quality of the set area.
- 4** Click 'Save' to save the current settings.
  - ☒ Click 'Cancel' to return to the previous setting.

# Setup - Video & Audio Setup

## Privacy Mask Configuration

---

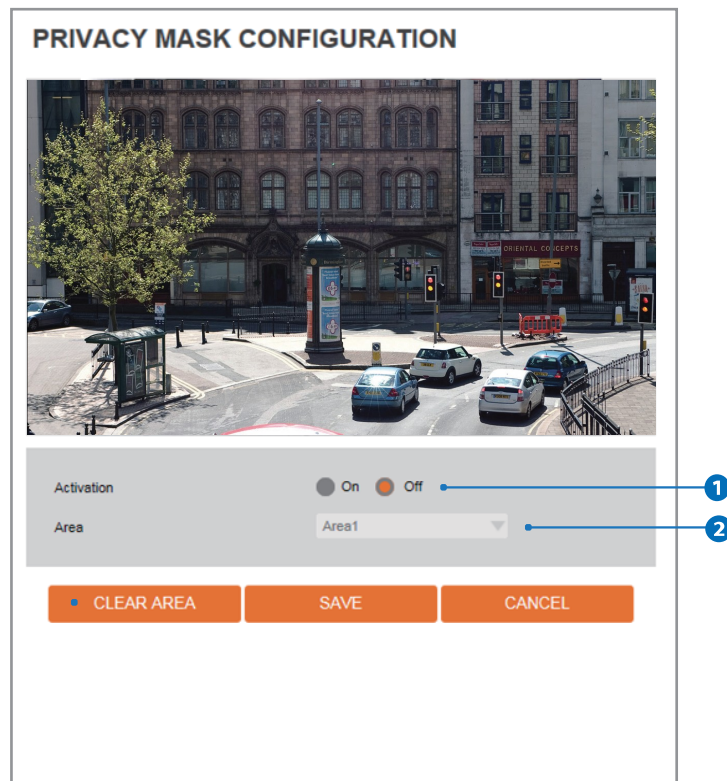

Use this function to mask areas that you want to hide on screen to protect privacy.

- 1 Activation** - The Privacy mask function can be enable or disable.
- 2 Area** - Select the Area1 ~ Area16 and Set the privacy area.
- 3** Click 'Save' to save the current settings.
  - ⌘ Click 'Cancel' to return to the previous setting.
  - ⌘ Click 'Clear Area' to delete the selected Area1~Area16.

# Setup - Camera Setup

## Camera Image Adjustment

---

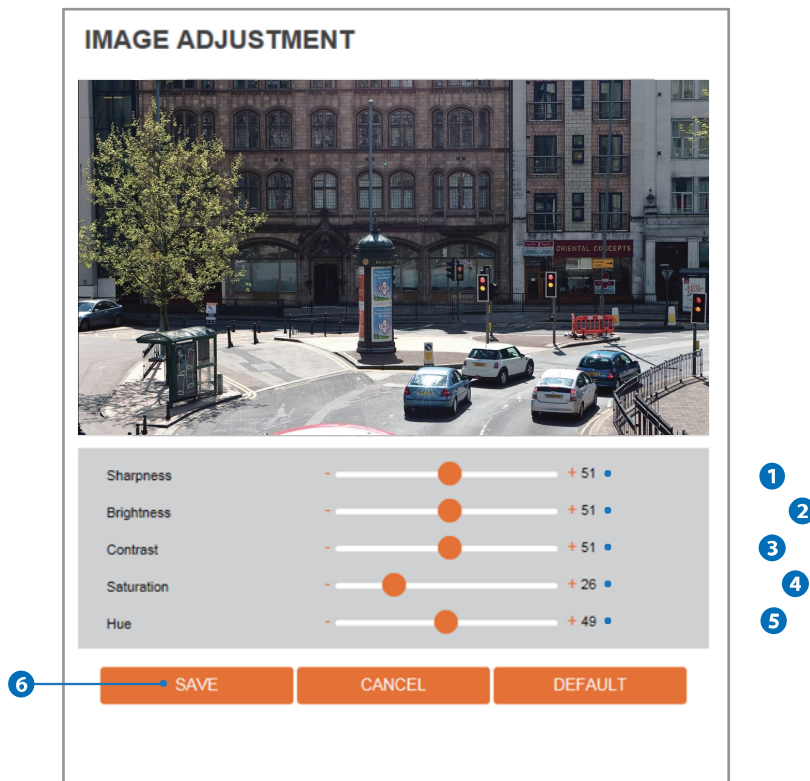

- 1 **Sharpness** - Using this control, sharpness of image can be adjusted to meet your preference.
- 2 **Brightness** - Using this control, brightness of image can be adjusted to meet your preference.
- 3 **Contrast** - Using this control, contrast of image can be adjusted to meet your preference.
- 4 **Saturation** - Using this control, Saturation of image can be adjusted to meet your preference.
- 5 **Hue** - Using this control, Hue of image can be adjusted to meet your preference.
- 6 Click 'Save' to save the current settings.
  - ⌘ Click 'Cancel' to return to the previous setting.
  - ⌘ Click 'Default' to settings to the factory defaults.

# Setup - Camera Setup

## Camera Exposure Settings

---

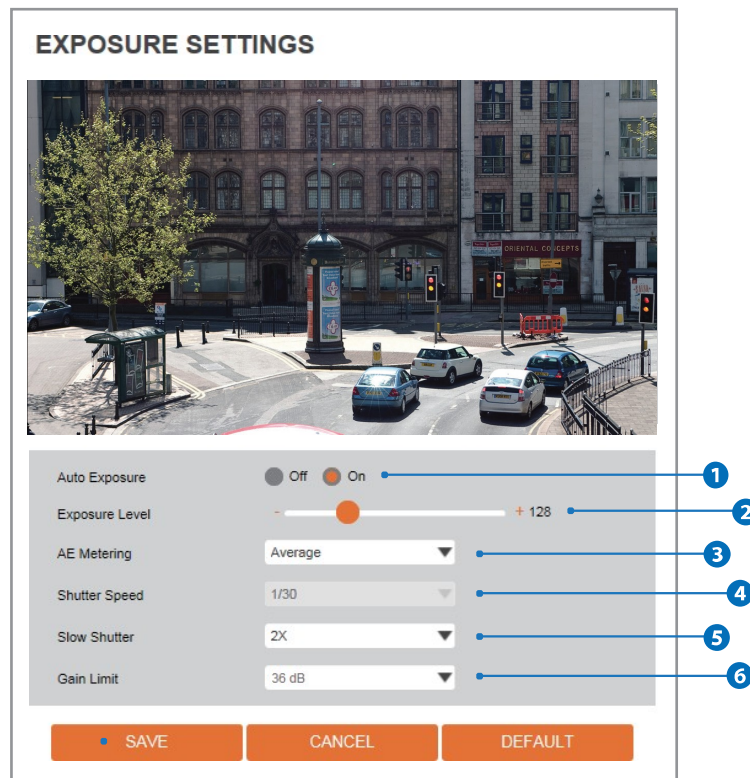

- 1 Auto Exposure** - Automatic exposure(AE) automatically sets the aperture or shutter speed, based on the external lighting conditions for the photo.
- 2 Exposure Level** - If this value is increases, the image becomes brighter.
- 3 AE metering** - AE metering mode refers to the way in which a camera determines the exposure.
- 4 Shutter Speed** - If this speed is faster, the moving object can be photographed without the ghost effect. However, picture can be dark if there is no sufficient lighting.
- 5 Slow Shutter Level** - Slow shutter Level lets you adjust the amount of light striking the sensor, and essentially determines when the video sensor sends out its batch of data for processing.
- 6 Gain Limit** - The smaller number makes the darker image.
- 7** Click 'Save' to save the current settings.
  - ⌘ Click 'Cancel' to return to the previous setting.
  - ⌘ Click 'Default' to settings to the factory defaults.

# Setup - Camera Setup

## Camera Day & Night Settings

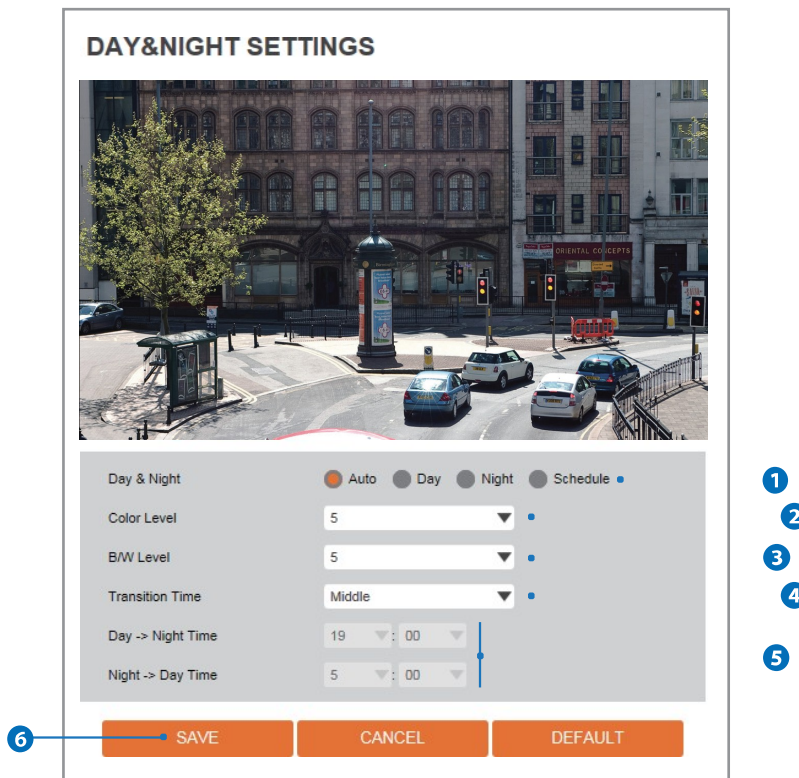

### 1 Day & Night

- **Auto:** In this mode, the IR cut filter is removed automatically depending on the light condition around.
- **Day:** In this mode, the IR cut filter is applied to the image sensor all the time. Thus, the sensitivity will be reduced in the dark light condition but the better color reproduction performance are obtained.
- **Night:** In this mode, the IR cut filter on the image sensor is removed all the time. The sensitivity will be enhanced in the dark light condition but the image is black and white.
- **Schedule:** In this mode, Day / Night mode is converted accordance with the scheduled time.

2 **Color Level** - It is a level to change Night mode into Day mode when Day & Night mode is Auto.

3 **B / W Level** - It is a level to change Day mode into Night mode when Day & Night mode is Auto.

4 **Transition Time** - If it is set to Auto, to determine the rate at which Day / Night is converted.

5 If it is set to schedule mode, Set the time that Day / Night is converted.

6 Click 'Save' to save the current settings.

☒ Click 'Cancel' to return to the previous setting.

☒ Click 'Default' to settings to the factory defaults.

# Setup - Camera Setup

## Camera Backlight Settings

---

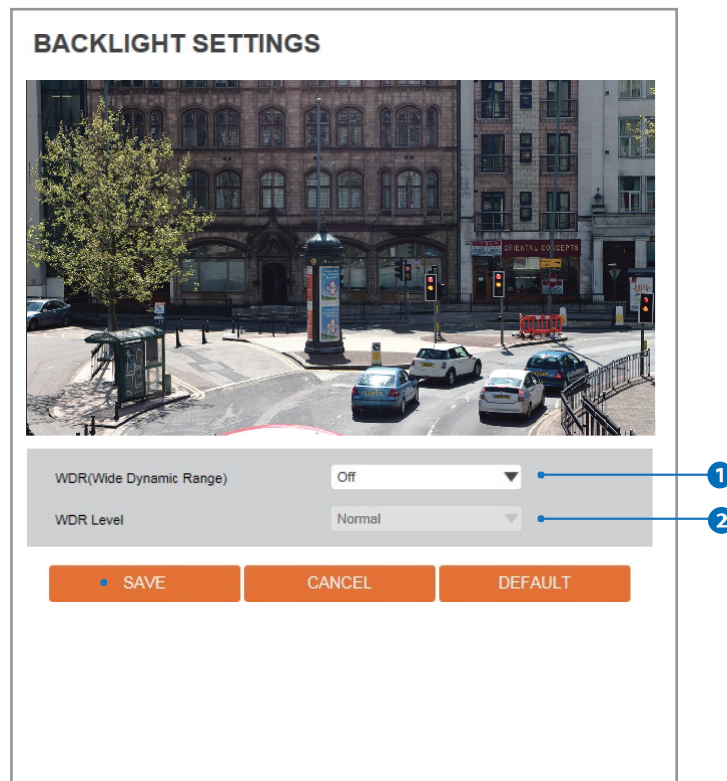

This is a feature used for problematic light conditions where the contrast from light to dark areas is very high.

- 1 **WDR (Wide Dynamic Range)** - The WDR function can be enable or disable.
- 2 **WDR Level** - Select the WDR level depending on the difference in brightness between the darkest and lightest part of an image.
- 3 Click 'Save' to save the current settings.
  - ⊠ Click 'Cancel' to return to the previous setting.
  - ⊠ Click 'Default' to settings to the factory defaults.

# Setup - Camera Setup

## Camera White Balance

---

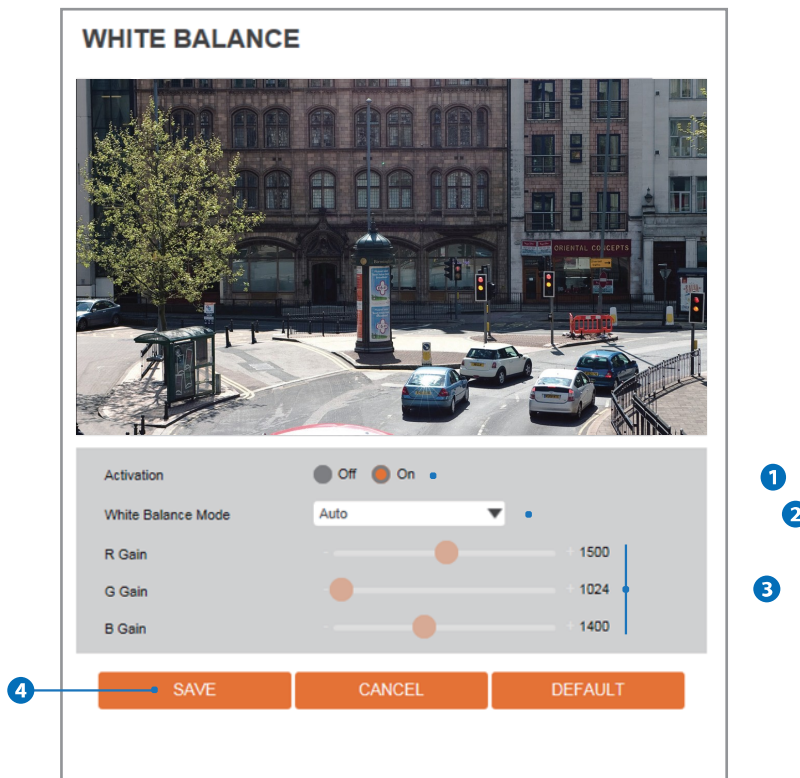

- 1 **Activation** - White Balance can be enable or disable.
- 2 **White Balance Mode** - Select White Balance depending on the lighting conditions.
- 3 **RGB Gain** - The R/G/B gain can be set only when the White Balance Mode is set to Manual.
- 4 Click 'Save' to save the current settings.
  - ⌘ Click 'Cancel' to return to the previous setting.
  - ⌘ Click 'Default' to settings to the factory defaults.



# Setup - Camera Setup

## Camera Image Enhancement

---

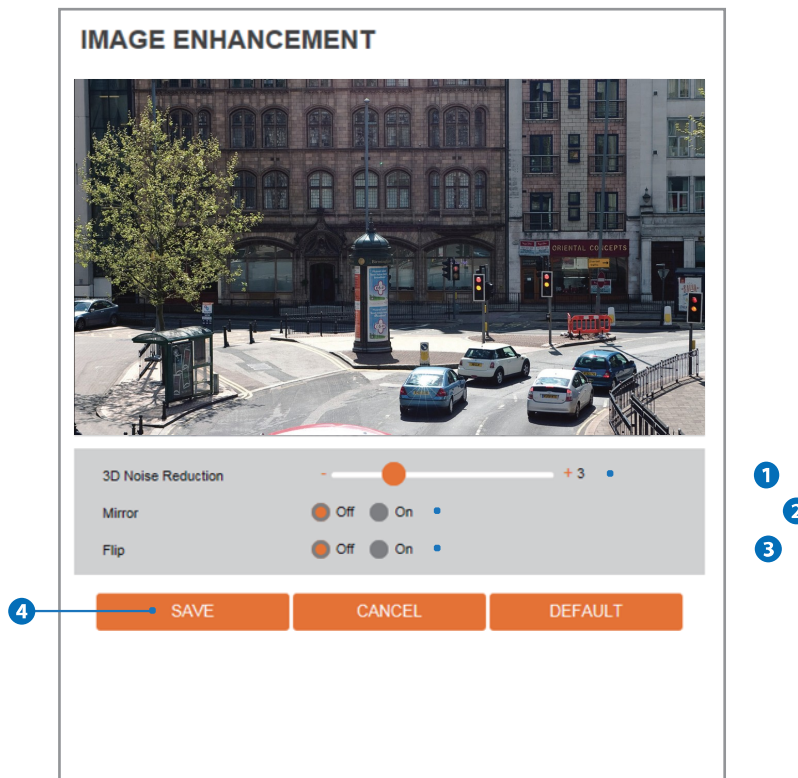

- 1 **3D Noise Reduction** - 3DNR function enables to suppress noise and retain good video quality in low light conditions.
- 2 **Mirror** - Reverse the video from side to side.
- 3 **Flip** - Reverse the video from up to down.
- 4 Click 'Save' to save the current settings.
  - ⌘ Click 'Cancel' to return to the previous setting.
  - ⌘ Click 'Default' to settings to the factory defaults.

# Setup - Camera Setup

## Video Enhancement

---

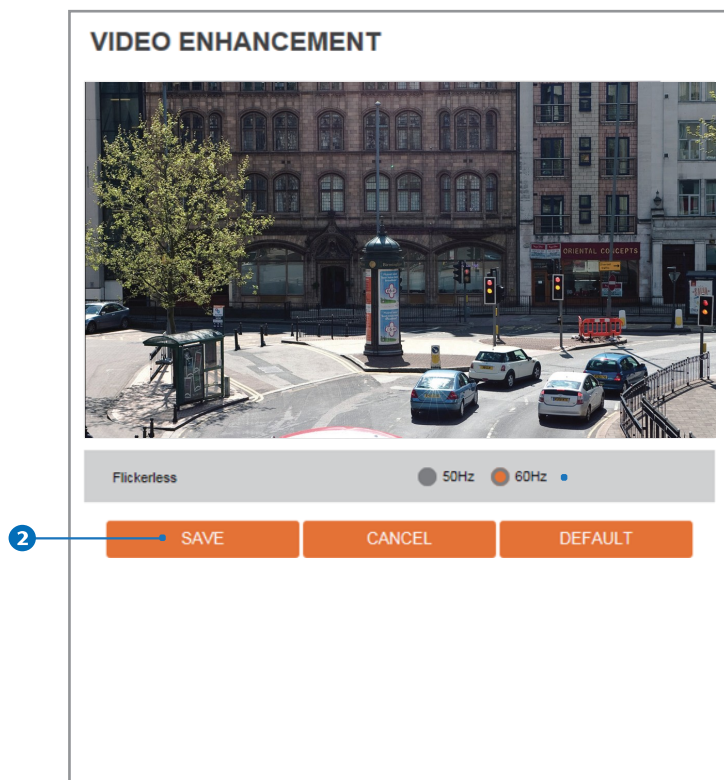

1 **Flicker** - This function Enable to enhance the flicker situation.

2 Click 'Save' to save the current settings.

☒ Click 'Cancel' to return to the previous setting.

☒ Click 'Default' to settings to the factory defaults.

# Setup - Network Setup

## Network Status

---

NETWORK STATUS	
MAC Address	00:0D:3F:2F:8C:C3
IP Address	192.168.1.44
Subnet Mask	255.255.0.0
Default Gateway	192.168.1.1
Preferred DNS Server	203.248.252.2
Alternate DNS Server	164.124.101.2
HTTP Port	80
HTTPS Port	443
RTSP Port	554

This menu will show you all the information of Network setting in the camera. However, you cannot change those here.

# Setup - Network Setup

## Network Settings

---

**NETWORK SETTINGS**

**Network Type**

Static  Dynamic

**IP setup**

IP Address: 192.168.1.113

Subnet Mask: 255.255.255.0

Default Gateway: 192.168.1.1

Preferred DNS Server: 168.126.63.1

Alternate DNS Server: 168.126.63.2

**Port Setup**

HTTP Port: 80 [ Default: 80, 1025 ~ 60000 ]

HTTPS Port: 443 [ Default: 443, 1025 ~ 60000 ]

RTSP Port: 554 [ Default: 554, 1025 ~ 60000 ]

**APPLY**

- 1 **Network Type** - Define network IP address type from the Static Mode for the fixed IP or the Dynamic Mode by the dynamic IP address. If you select the Static Mode, you must fill out IP Address, Subnet Mask, Gateway, DNS Server and all ports. If you select the Dynamic Mode, the IP address will be allocated automatically by DHCP equipment. If you click the Apply button to update changes, the system will be re-booted. In this case, you have to reconnect the camera using new IP address.
  - 2 **IP Address** - Define the IP address. The address is consisted of four numbers separated by dots and the range of each number is from 0 to 255.
  - 3 **Subnet Mask** - Define the Subnet Mask. Format is same as the IP address.
  - 4 **Default Gateway** - Default the Gateway IP Address. Format is same as the IP address.
  - 5 **Preferred DNS Server** - Define the DNS server IP address. Format is same as the IP address.
  - 6 **Alternate DNS Server** - Define the Secondary DNS server IP address. Format is same as the IP address.
  - 7 **HTTP Port** - The HTTP port can be set to 80 which default or in between 1025 to 60000.
  - 8 **HTTPS Port** - The HTTPS port can be set to 443 which default or in between 1025 to 60000.
  - 9 **RTSP Port** - The RTSP port can be set to 554 which default or in between 1025 to 60000.
  - 10 Click 'Apply' to make above setting effective.
- ⊗ If the network type is dynamic, the IP address is changed in below cases. Therefore, the IP address needs to be searched again, and the camera needs to be reconnected in these cases.
- When the camera power is on / off.
  - After Firmware update, Default set and reboot.

# Setup - Network Setup

## Auto IP Settings

---

**AUTO IP SETTINGS**

**General Setting**

Off  On

UNIQUE ID	a832a4fb-8821-4c35-b232-66c415d674a5
AUTO IP ADDRESS	169.254.189.3

**APPLY**

- 1 **General Setting** - Auto IP Settings function can be enable or disable.
- 2 **Auto IP Settings Information** - It displays the unique id or Auto IP address.
- 3 Click 'Apply' to make above setting effective.

# Setup - Network Setup

## ONVIF Settings

---

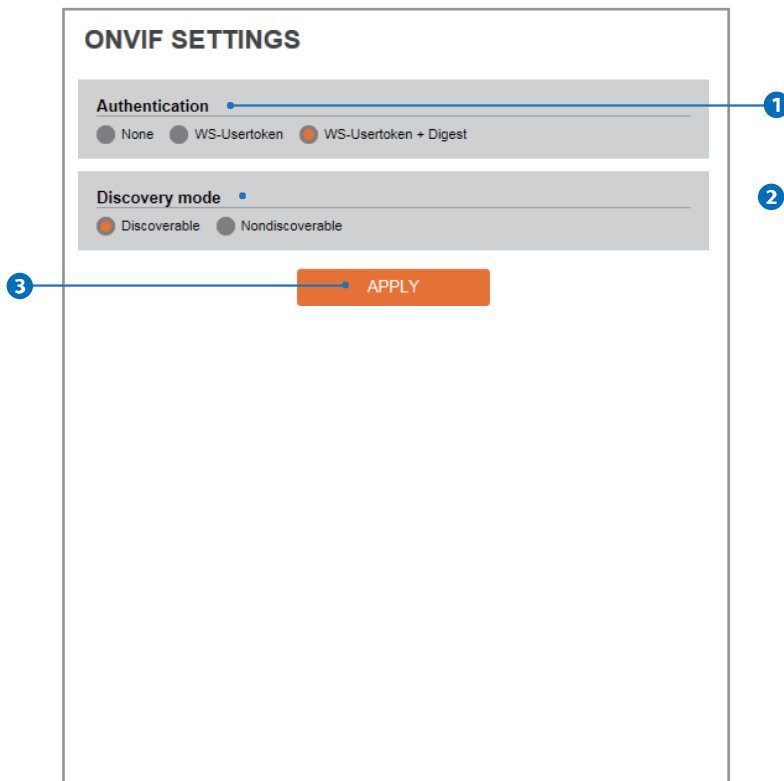

### 1 Authentication

**None:** Allows to access without ONVIF authentication.

**WS - Usertoken:** Allows to access with WS-User Token of ONVIF authentication.

**WS - Usertoken + Digest:** Allows to access with WS-User Token and Digest of ONVIF authentication.

### 2 Discovery Mode - The discovery function can be enable or disable.

### 3 Click 'Apply' to make above setting effective.

# Setup - Network Setup

## UPNP Settings

---

The screenshot shows the 'UPNP SETTINGS' interface. It is divided into two main sections: 'General Setting' and 'Device Information'. The 'General Setting' section has a toggle switch for 'Off' and 'On'. The 'Device Information' section has a text input field for 'FriendlyName' with the value 'IPNC N5F2-ALAH2'. At the bottom, there is an orange 'APPLY' button. Three numbered callouts (1, 2, and 3) point to the 'General Setting' section, the 'FriendlyName' input field, and the 'APPLY' button, respectively.

- 1 **General Setting** - UPNP function can be enable or disable.
- 2 **Friendly Name** - Define the friendly name. Click
- 3 'Apply' to make above setting effective.

# Setup - Network Setup

## DDNS Settings

---

**1 DDNS Disable** - If it is selected, DDNS service does not work.

**2 Public DDNS** - To use public DDNS service, select a site address listed in the list. After filling out the Host Name of the site, the setup is completed by entering User Name and Password registered in that DDNS site.

DDNS Provider	Site Address
DynDNS	www.dyndns.com
No-IP	www.no-ip.com

☒ If you setup DDNS properly, the IP address of your camera will be updated automatically whenever IP address is changed or system is rebooted.

☒ If IP updating to DDNS site is failed, camera will keep retrying in 1min. interval.

**3** Click 'Apply' to make above setting effective.



# Setup - Network Setup

## FTP Settings

---

**FTP SETTINGS**

**General Setting**

Off  On

**Server information**

FTP Server Address

FTP Upload Path /

FTP Port 21

User ID

Password

APPLY

To transfer / save the image to the relevant sites through FTP, then FTP needs to be setup.

- 1 General Setting** - FTP function can be enable or disable.
- 2 FTP Server Address** - Define FTP Server IP Address. If IP Address form is incorrect, a Message box will be shown to try again.
- 3 FTP Upload Path** - Define a path in FTP server to store video. For the path name, English Alphabets, numbers and special characters ( / ~ ! @ \$ ^ ( ) \_ - { } [ ] ; , ) can be used.
- 4 FTP Port** - Define the FTP Server Port. If Port is not appropriate, it is impossible to access to FTP Server.
- 5 User ID** - Define User ID to access to the FTP Server. Fill out the correct User ID registered in the FTP Server.
- 6 Password** - Define Password to access to the FTP Server. Fill out the correct Password registered in the FTP Server.
- 7** Click 'Apply' to make above setting effective.  
☒ Refer the above screen image for the example.

# Setup - Network Setup

## SMTP Settings

---

The screenshot shows the 'SMTP SETTINGS' configuration page. It is divided into three main sections: 'General Setting', 'Account information', and 'Mail Contents'. The 'General Setting' section has a toggle for 'Off' (selected) and 'On'. The 'Account information' section includes fields for 'Mode' (PLAIN or SSL/TLS), 'SMTP Server Address', 'PORT' (set to 25), 'User ID', 'Password', 'E-Mail Sender', and 'E-Mail Receiver'. The 'Mail Contents' section has fields for 'Title' and 'Message'. At the bottom, there is an 'APPLY' button. Numbered callouts (1-11) point to various elements: 1 points to the General Setting header, 2 to the Mode radio buttons, 3 to the SMTP Server Address field, 4 to the PORT field, 5 to the User ID field, 6 to the Password field, 7 to the E-Mail Sender field, 8 to the E-Mail Receiver field, 9 to the Title field, 10 to the Message field, and 11 to the APPLY button.

To send / save the image to the relevant sites by Email, SMTP needs to be setup.

- 1 **General Setting** - SMTP function can be enable or disable.
- 2 **Mode** - Select Security mode of SMTP from Plain or SSL / TLS. After checking account setup of your SMTP Server, you may select one.
- 3 **SMTP Server Address** - Define the SMTP Server Address. If the IP Address form is incorrect, a Message box will be shown to try again.
- 4 **Port** - Define the Port used in the Plain or SSL / TLS security mode in the above.
- 5 **User ID** - Define the User ID to access to SMTP Server. Fill out the correct User ID registered in the SMTP Server.
- 6 **Password** - Define the Password to access to SMTP Server. Fill out the correct Password registered in the SMTP Server.
- 7 **E-Mail Sender** - Define the e-mail address of E-Mail Sender. It will be displayed as the sender when the camera sends an E-mail.
- 8 **E-Mail Receiver** - Define the e-mail address of E-Mail Receiver. It will be displayed as the Receiver when the camera sends an E-mail.
- 9 **Title** - Define the title of the E-Mail when the camera sends an E-mail.
  - ✘ The title of the Email is limited to 40 characters including the spaces.
- 10 **Message** - Define the contents of E-Mail when camera sends an E-mail. The message of the Email is limited to 40 characters including the spaces.
- 11 Click 'Apply' to make above setting effective.

# Setup - Network Setup

## SNMP Settings

The screenshot shows the 'SNMP SETTINGS' configuration page. It is divided into three main sections: 'SNMP v1/v2c', 'SNMP v3', and an 'APPLY' button at the bottom. The 'SNMP v1/v2c' section includes fields for 'SNMPV1' and 'SNMPV2' (each with 'Off' and 'On' radio buttons), 'Read Community' (text input: 'public'), 'Write Community' (text input: 'private'), 'SnmpTrap' (radio buttons), 'TrapAddress' (text input: '0.0.0.0'), and 'TrapCommunity' (text input: 'public'). The 'SNMP v3' section includes a 'Mode' dropdown menu (set to 'Read'), an 'Activation' section with radio buttons, and several text input fields: 'Read Name' (set to 'root'), 'Security Level' (dropdown: 'no auth, no priv'), 'Authentication Algorithm' (dropdown: 'MD5'), 'Authentication Password' (text input), 'Private-Key Algorithm' (dropdown: 'DES'), and 'Private-Key Password' (text input). A blue vertical line with a dot is positioned to the right of the 'SNMP v1/v2c' section. Numbered callouts (1-11) are placed around the interface: 1 points to the 'SNMPV1' and 'SNMPV2' radio buttons; 2 points to the 'TrapAddress' field; 3 points to the 'Mode' dropdown; 4 points to the 'Activation' radio buttons; 5 points to the 'Read Name' field; 6 points to the 'Security Level' dropdown; 7 points to the 'Authentication Algorithm' dropdown; 8 points to the 'Authentication Password' field; 9 points to the 'Private-Key Algorithm' dropdown; 10 points to the 'Private-Key Password' field; and 11 points to the 'APPLY' button.

1 **SNMPv1/SNMPv2** - Select the SNMPv1/SNMPv2 option and type the names of Read community and Write community.

SNMP trap can be used to check periodically for operational thresholds or failures that are defined in the MIB.

2 **SNMP Trap** - SNMP trap can be enable or disable.

SNMPv3 contains cryptographic security, a higher security level, which allows you to set the Authentication password and the Encryption password.

3 **Mode** - Select the either Read or Read/Write mode.

4 **Activation** - It can be enable or disable selected mode.

5 **Read/Write name** - Define Read name and Write name.

6 **Security Level** - Select one of no auth, no priv/auth , no priv/auth, priv

7 **Authentication Algorithm** - Select MD5 or SHA as the authentication method.

8 **Authentication Password** - The Authentication Password is an encryption for authentication and they are at least 8 digits and up to 30 digits allowed.

9 **Private-Key Algorithm** - Select DES or AES as the encryption algorithm.

10 **Private-Key Password** - Information protection password is a private encryption and they are at least 8 digits and up to 30 digits allowed.

11 Click 'Apply' to make above setting effective.

# Setup - Network Setup

## RTSP Information

---

The screenshot shows the 'RTSP INFORMATION' configuration page. It is divided into several sections: 'RTSP Global Setting' with a 'Target Stream' dropdown set to 'Channel1'; 'Session Timeout' with a 'Time Out' input set to '0' and a checkbox for '[Default: Off, 30~120]'; 'Rtp Multicast' with a 'MULTICAST' toggle set to 'Off', and input fields for 'IP' (0.0.0.0), 'PORT' (0), and 'TTL' (0). Below these is an orange 'APPLY' button. At the bottom is a table with one row of connection information. Five blue callout boxes with numbers 1 through 5 point to the 'Target Stream' dropdown, the 'Time Out' input, the 'MULTICAST' toggle, the 'APPLY' button, and the table header, respectively.

No	Remote IP	Port	Type
1	192.168.1.39	49622	TCP

- 1 Target Stream** - Select the channel you want to set.
- 2 Time out** - Set the RTSP time out.
  - ⊗ The session is disconnected after the specified time out.
- 3 RTP Multicast** - Check RTP Multicast On/Off. To activate RTP Multicast.
  1. Click "On" button
  2. Enter accessible RTP Multicast IP, port for video stream control, RTP packet TTL
  3. Click "Apply" button.
  - ⊗ It is possible to set each RTP Multicast for CH1~3.
- 4** Click 'Apply' to make above setting effective.
  - ⊗ Click this button when completed setup each channels.
- 5** It shows RTSP Connection information.

# Setup - Trigger Action Setup

## Action Rules Configuration

---

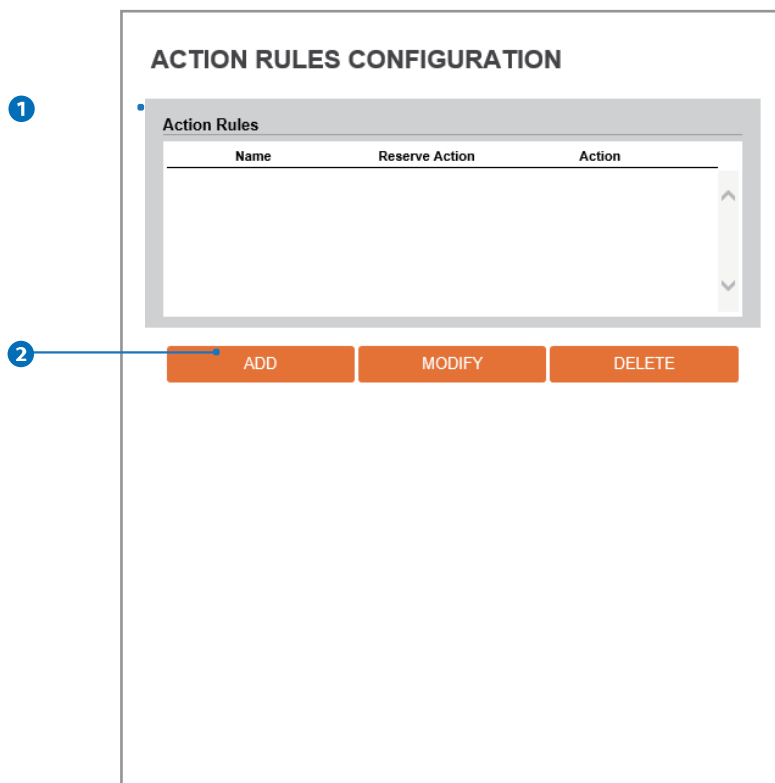

**1 Action rules List** - It indicates the custom action rule information added to Action rules list.

**2** Click 'Add' to add custom action rules.

✘ Click 'Modify' to modify selected item from the action rules list.

✘ Click 'Delete' to delete selected item from the action rules list.

# Setup - Trigger Action Setup

## Action Rules Add / Modify

---

**ACTION RULES CONFIGURATION**

**General Setting**

Name

Action1

Action2

Action3

Action4

Action5

1 **Name** - Define name of action rules.

2 **Action1 ~ Action5** - Select the action to take if the event occurs.

3 Click 'Save' to save the current settings.  
⌘ Click 'Cancel' to return to the previous menu.

# Setup - Trigger Action Setup

## Image Transfer Configuration

---

**IMAGE TRANSFER CONFIGURATION**

**Pre/Post Alarm Image**

Number Of Image: 2 Image Per Seconds(s) [ 1 ~ 5 ]

Pre-Alarm Duration: 3 Second(s) [ 1 ~ 5 ]

Post-Alarm Duration: 3 Second(s) [ 1 ~ 30 ]

APPLY

**1 Pre / Post Alarm Image** - Image Transfer due to event is configured by setting Image transfer rate and Pre / Post alarm duration.

	Descriptions
Number of Image	Define Number of image transferred per second.
Pre-alarm Duration	Define duration of image transfer before an event.
Post-alarm Duration	Define duration of image transfer after an event.

**2** Click 'Apply' to make above setting effective.

# Setup - Event Setup

## Event Rules Configuration

---

**EVENT RULES CONFIGURATION**

Event Rules

Name	Reserve Event	Schedule	Action
NewRule	Motion Detection	Always	SMTP
NewRule2	Network Disconnected	Always	FTP

ADD    MODIFY    DELETE

1 **Event Rules List** - It indicates the custom Event Rule information added to Event Rules list.

2 Click 'Add' to add custom event rules.

⊠ Click 'Modify' to modify selected item from the event rules list.

⊠ Click 'Delete' to delete selected item from the event rules list.



# Setup - Event Setup

## Event Rules Configuration

---

The screenshot shows a form titled "EVENT RULES CONFIGURATION" with three main sections: "General", "Event Condition", and "Action".

- General:** Contains a "Name" field with the value "NewRule". A blue line with a circled "1" points to this field.
- Event Condition:** Contains an "Event" dropdown menu with "NONE" selected. A blue line with a circled "2" points to this dropdown.
- Action:** Contains a "Rules" dropdown menu with "NONE" selected. A blue line with a circled "3" points to this dropdown.
- At the bottom, there are two orange buttons: "SAVE" and "CANCEL". A blue line with a circled "4" points to the "SAVE" button.

**1 Name** - Define the Event rule name.

**2 Event** - Select the event among motion detection, network disconnection, temperature critical.

- ⊠ Click 'Cancel' to return to the previous setting.
- ⊠ You need a event one more.

**3 Rules** - Select the action rule defined in the Trigger Action-Action rule menu.

**4** Click 'Save' to save the current settings.

- ⊠ Click 'Cancel' to return to the previous setting.

# Setup - Event Setup

## Motion Detection Configuration

---

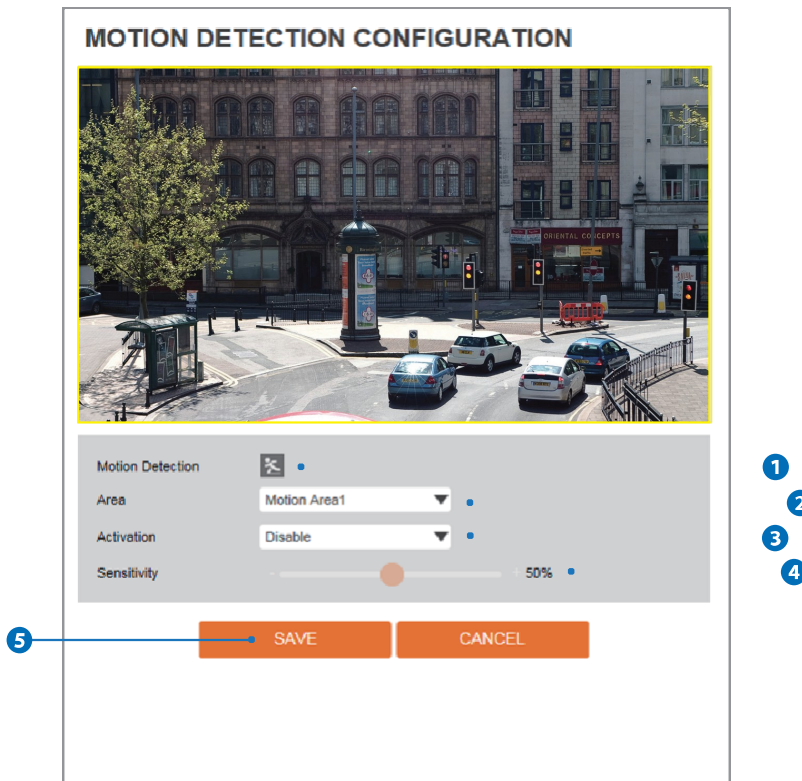

**1 Motion Detection** - It shows the Motion event status.

☒ Event Alert Icon(  ) appears if 'Motion Detection' is activated.

**2 Area** - Set the motion detected area.

☒ You can set up to four areas.

**3 Activation** - Enable or Disable motion detection function.

**4 Sensitivity** - Define the sensitivity of motion detection. If High value is selected, it will detect very small motion while it becomes relatively insensitive when Low value is selected.

**5** Click 'Save' to save the current settings.

☒ Click 'Cancel' to return to the previous setting.

# Setup - Event Setup

## Temperature

---

The screenshot shows a web interface titled "TEMPERATURE" with a "General Setting" section. The settings are as follows:

Field	Value	Range/Unit
Mode	Fahrenheit	
Threshold	150	[ 122 ~ 212 ]
Temperature	120 °F	

Below the settings is an orange "APPLY" button. Numbered callouts are: 1 points to the Mode dropdown, 2 points to the Threshold input field, 3 points to the Temperature display, and 4 points to the APPLY button.

- 1 **Mode** - Select the either Fahrenheit and Celsius.
- 2 **Threshold** - Define the temperature at which the event trigger is occurred.
- 3 **Temperature** - It indicates the current temperature of the IP camera.
- 4 Click 'Apply' to make above setting effective.

# Setup - Edge Setup

## DW Spectrum<sup>®</sup> Edge

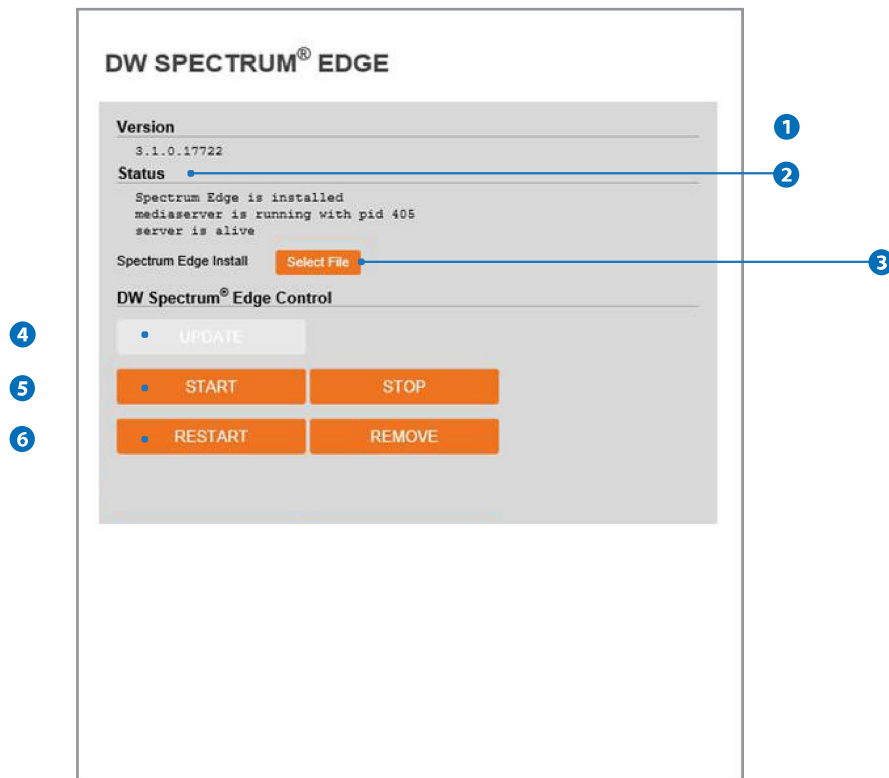

- 1 **Version** - Displays the version of DW Spectrum<sup>®</sup> edge (media server) installed in the camera.
- 2 **Status** - Displays the status of the DW Spectrum<sup>®</sup> edge (media server) installed in the camera. Wait until the status of the server is marked as 'alive'.
- 3 Select a new version of DW Spectrum<sup>®</sup> edge (media server) file to update and upload.
- 4 Update with selected file. If you select file, it will be activated.
- 5 **DW Spectrum<sup>®</sup> edge (media server) start / stop**
  - Start : Start the DW Spectrum<sup>®</sup> edge (media server) installed in the camera.
  - Stop : Close the DW Spectrum<sup>®</sup> edge (media server) installed in the camera.
- 6 **DW Spectrum<sup>®</sup> edge (media server) restart / remove**
  - Restart : Restart the DW Spectrum<sup>®</sup> edge (media server) installed in the camera.
  - Remove : Delete the DW Spectrum<sup>®</sup> edge (media server) installed from the camera.

### ⌘ Before DW Spectrum<sup>®</sup> edge (media server) install.

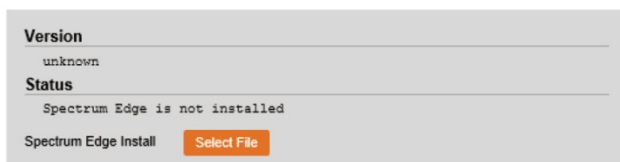

# Setup - Edge Setup

## Storage Configuration

---

**STORAGE CONFIGURATION**

**Notice**

1. If SD Card does not automatically mount, you must format for mounting SD card.

**Storage List**

Name	Mounted	Size	Used(%)	Available
sdcard0	0	29.8G	4%	28.5G

**Display the SD card information mounted from device.**

☒ When you select the item in Storage list, You can set the functions related to the SD card.

# Setup - Edge Setup

## Storage Configuration

---

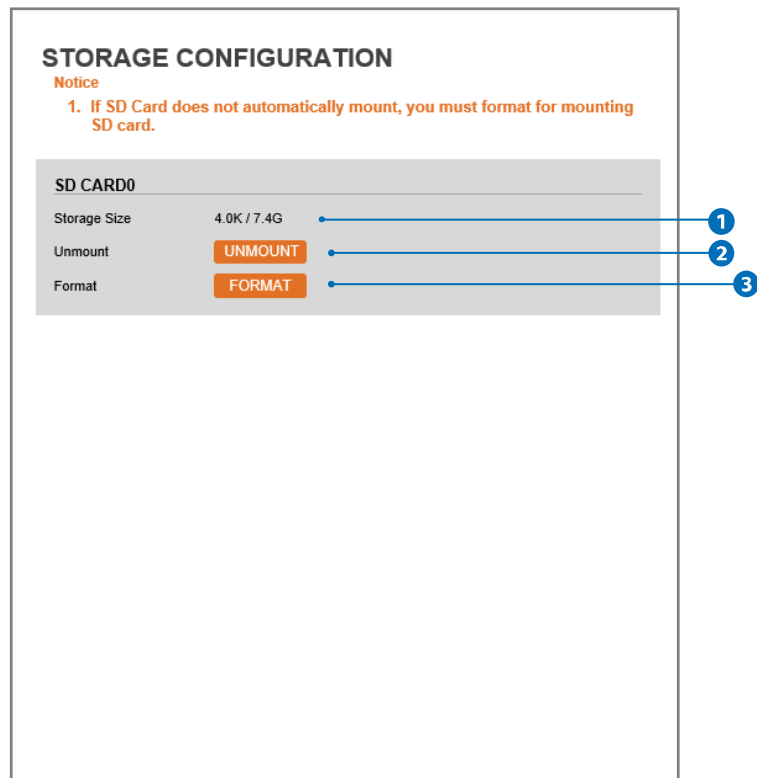

- 1 **Storage Size** - Total capacity of SD card and the remainder of it are displayed.
- 2 **Unmount** - Remove the SD card from the device. UNMOUNT cannot be done when EDGE (Media server) is running.
- 3 **Format** - Delete the all contents that stored in SD card. FORMAT cannot be done when EDGE (Media server) is running..

# Setup - Security Setup

## IP Address Filter Configuration

---

The screenshot shows the 'IP ADDRESS FILTER CONFIGURATION' interface. It is divided into several sections:

- General Setting:** Contains a toggle for 'IP Address Filter' (set to 'On') and a dropdown for 'IP Filter Type' (set to 'Allow').
- APPLY:** An orange button to save the settings.
- Filtered IP Address:** A table with one header row 'IP Address' and an empty list area below it.
- IP Address:** A text input field with a placeholder '[Invalid]'.
- Buttons:** Three orange buttons: 'ADD', 'REMOVE', and 'REMOVE ALL'.

Numbered callouts (1-6) are placed around the interface to indicate key steps: 1 points to the 'IP Address Filter' toggle, 2 to the 'IP Filter Type' dropdown, 3 to the 'APPLY' button, 4 to the 'Filtered IP Address' table, 5 to the 'IP Address' input field, and 6 to the 'ADD' button.

- 1 **IP Address Filter** - IP filter function can be enable or disable.
- 2 **IP Filter Type** - Select the recording IP filter type.
- 3 Click 'Apply' to make above setting effective.
- 4 **Filter IP Address** - Display the filtered IP address.
- 5 **IP Address** - Define the IP address you want to apply the IP filter.
- 6 Click 'Add' to add the ip address to the list.
  - ⊠ Click 'Remove' to remove the ip address selected in the list.
  - ⊠ Click 'Remove All' to remove all ip in the list.

# Setup - Security Setup

## RTSP Authentication Configuration

---

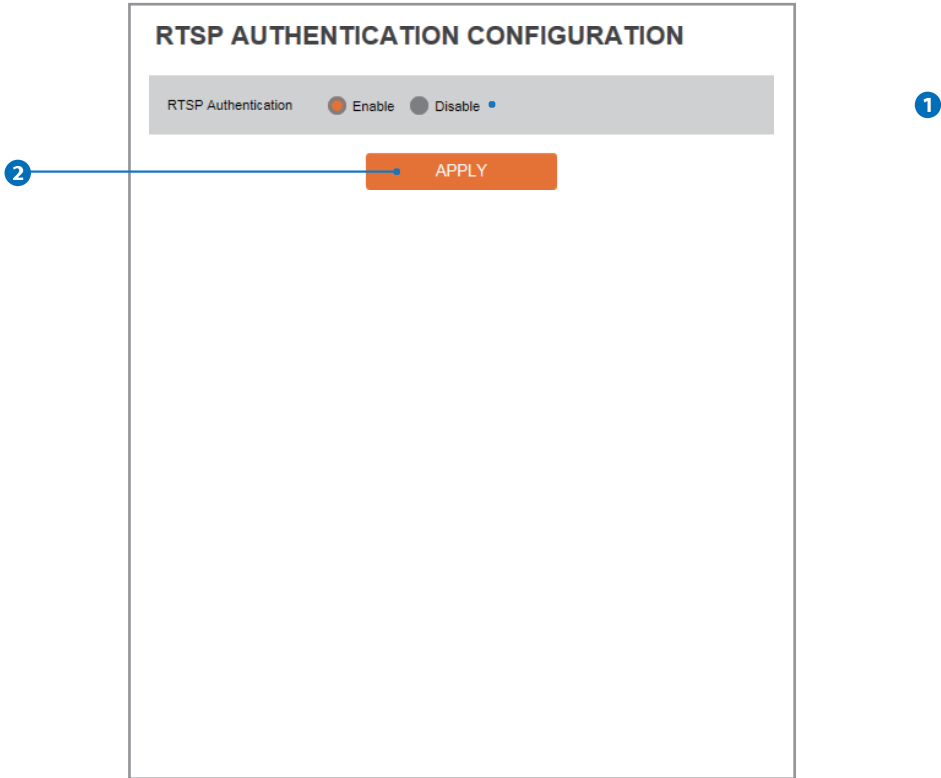

1 **RTSP Authentication** - RTSP Authentication can be enable or disable.

2 Click 'Apply' to make above setting effective.



# Setup - Security Setup

## IEEE 802.1X Configuration

---

**IEEE 802.1X CONFIGURATION**

**General Setting**

IEEE 802.1x  On  Off

Protocol

EAPOL Version

ID

Password

Verify

CA Certificate

Certificate

The feature is needed when connecting the camera to the network protected by the IEEE 802.1X.

- 1 **IEEE 802.1x** - The IEEE 802.1x feature can be enable or disable.
- 2 **Protocol**
  - **MD5** : It provides one-way password-based network authentication of the client.
  - **PEAP** : It is similar to TTLS in that it does not require a certificate on the client side.
  - **TTLS / MD5** : It does not require a certificate on the client side.
  - **TLS** : It relies on client-side and server-side certificates to perform authentication.
- 3 **EAPOL Version** - Select the EAPOL Version.
- 4 **ID** - Type the ID to identify the client in the IEEE 802.1X authentication server.
- 5 **Password** - Type the Password to identify the client in the IEEE 802.1X authentication server.
- 6 **Verify** - Verify Password.
- 7 **CA Certificate** - Select the CA certificate required for TLS, TTLS, and PEAP authentication.
- 8 **Certificate** - Select the client certificate required for TLS authentication
- 9 Click 'Apply' to make above setting effective.

# Setup - Security Setup

## HTTPS Configuration

---

The screenshot shows the 'HTTPS CONFIGURATION' interface. At the top, there is a red warning message: '1. If no certificates are available go to certificates to manage.' Below this, there are two main sections: 'Certificates' and 'HTTPS connection Policy'. The 'Certificates' section has a 'Certificate' dropdown menu currently set to 'NONE'. The 'HTTPS connection Policy' section has three dropdown menus for 'Administrator', 'Operator', and 'Viewer', all set to 'HTTP and HTTPS'. At the bottom of the configuration area is an orange 'APPLY' button. Three blue callout boxes with numbers 1, 2, and 3 are positioned to the right of the interface. Callout 1 points to the 'Certificate' dropdown, callout 2 points to the 'Administrator' dropdown, and callout 3 points to the 'APPLY' button.

HTTPS encrypts session data over SSL or TLS protocols instead of using plain text in socket communications.

- 1 Certificate** - Select an installed certificate.
  - ⊗ If you can not select a certificate, please install the certificate from the Security->Certificates menu.
- 2 HTTPS connection Policy** - Select one of "HTTP", "HTTPS", "HTTP and HTTPS" depending on the connected user authority.
- 3** Click 'Apply' to make above setting effective.
  - ⊗ When HTTPS mode is chosen, input `https://<IP Address>` to connect to the camera.

# Setup - Security Setup

## Certificates Configuration

---

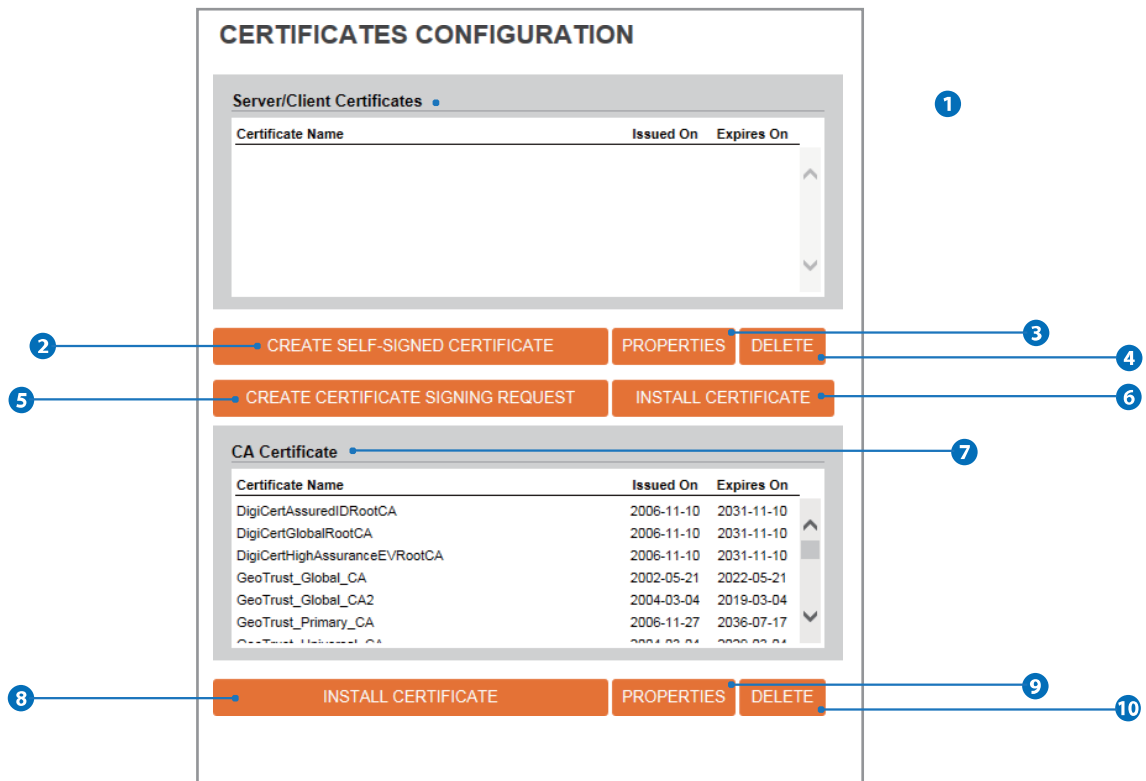

- 1 Server/Client Certificates** - It show the installed certificates.
- 2 Create Self-Signed Certificate** - A self-signed SSL certificate is an identity certificate signed by its own creator. but they are considered to be less trustworthy.
- 3 Properties** - Shows information about the selected certificate.
- 4 Delete** - Delete the selected certificate.
- 5 Create Certificate signing request** - This is the encoded data that contains the necessary information for issuing the certificate.  they must be filled in when creating the CSR (Certificate Signing Request).
- 6 Install Certificate** - Install Certification
- 7 CA Certificate** - It show the installed CA certificates.
- 8 Install CA Certificate** - Install Certification, see the detail page.
- 9 Properties** - Shows information about the selected certificate.
- 10 Delete** - Delete the selected CA certificate.

# Setup - Security Setup

## Certificates Configuration

---

**CERTIFICATES CONFIGURATION**

**Create Self-Signed Certificate**

Certificate Name:

Expires On:  ~2085-07-31 19:19:25

Country:

State Or Province:

Locality:

Organization:

Organization Unit:

Common Name:

RSA:

SHA:

**Install Certificate**

Certificate From Signing Request **1**

Certificate And Private Key **2**

Use Separate Key

PKCS#12

Password:

Certificate Name:  **3**

Certificate File:  **4**

**5**  **6**

**Install CA Certificate**

Certificate Name:  **7**

Certificate File:  **8**

**9**  **10**

### Detail for Install Certification.

- 1 Certificate From Signing Request** - Select to install signed certificate returned from the CA.
- 2 Certificate And Private Key** - Select to install Certificate And Private Key to install a certificate and private key.
  - **Use Separate Key** : Too install certificate uploading Certificate and Private Key file.
  - **PKCS#12** : "PKCS#12" is cryptography standard. if you want to install using PKCS#12, must enter the password.
- 3 Certificate Name** - Enter a unique name to identify certificate.
- 4 Select File** - Choose certification file.
- 5 OK** - Request installing certificate.
- 6 Cancel** - Cancel install certificate and then back to certificates configuration.

### Detail for Install CA Certification.

- 7 Certificate Name** - Enter a unique name to identify CA certificate.
- 8 Select File** - Choose CA certification file
- 9 OK** - Request installing CA certificate.
- 10 Cancel** - Cancel install CA certificate and then back to certificates configuration.

# Setup - Security Setup

## Service Configuration

---

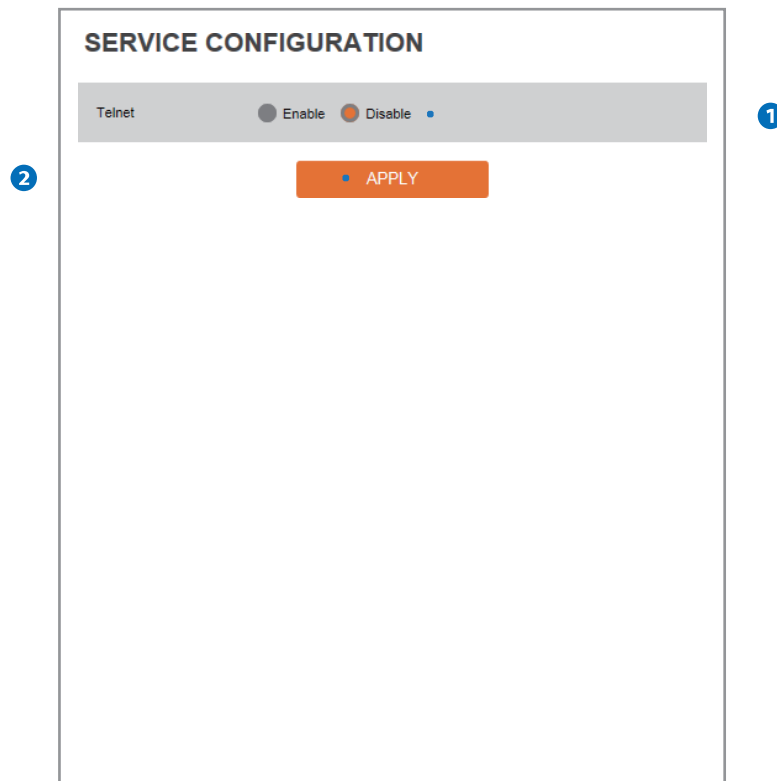

1 **Telnet** - The Telnet function can be enable or disable.

2 Click 'Apply' to make above setting effective.

# Setup - System Setup

## System Information

---

SYSTEM INFORMATION	
Device Name	IP-Camera
<b>APPLY</b>	
Model Name	N5Fx-ALAH
Manufacturer	IPNC
Max Resolution	1080p
Max Framerate	30 fps
Photo Resistor(CDS)	SUPPORT
Alarm In	NOT SUPPORT
Relay out	NOT SUPPORT
Audio	NOT SUPPORT
Optical Zoom	NOT SUPPORT
Digital Zoom	NOT SUPPORT
PTZ	NOT SUPPORT

### System Capability information.

- 1 **Device Name** - You can define the device name.
- 2 Click 'Apply' to make above setting effective.

# Setup - System Setup

## Firmware Update

---

The screenshot shows a web interface titled "FIRMWARE UPDATE". At the top, there is a "Notice" section with three red warning points. Below this is a "Version Information" section with a progress bar and a table showing "System" version 2016.4.22\_0.9.3 and "Camera" version 0.1. The next section is "Web update" with a "Firmware File" label and a "Select File" button. Below that is a "START FW UPDATE" button. The "FTP user information" section contains input fields for "FTP Server Address" (ftp.dwcc.tv), "FTP Port" (21), "User ID" (dwmpix), "Password" (masked with dots), and "FTP Upload Path" (/). At the bottom are three buttons: "SAVE", "CANCEL", and "CHECK". Three blue callout lines with numbered circles (1, 2, 3) point to the "Version Information" section, the "Select File" button, and the "START FW UPDATE" button respectively.

**1 Version Information** - It shows the current Firmware Version in the system.

**2 Web Update** - Select the Firmware file in your computer by clicking [Select file] button.

**3 Start F / W Update** - Click this button to start update. Progress of uploading will be displayed using Progress Bar. If you assign the wrong file name, an error message will be shown.

**⚠ Warning:**

1. Do not turn off the power of camera during the Firmware update. Otherwise, the system can be stuck to be unstable. If updating is finished, the system will be rebooted automatically.
2. Please make sure to check the 'Notice' shown on screen. If firmware update is completed, the camera will reboot automatically and 'Setup window' will be closed.

# Setup - System Setup

## Firmware Update

- 4 **FTP Server Address** - Define FTP Server IP Address. If IP Address form is incorrect, a Message box will be shown to try again.
- 5 **FTP Port** - Define the FTP Server Port. If Port is not appropriate, it is impossible to access to FTP Server.
- 6 **User ID** - Define User ID to access to the FTP Server. Fill out the correct User ID registered in the FTP Server.
- 7 **Password** - Define Password to access to the FTP Server. Fill out the correct Password registered in the FTP Server.
- 8 **FTP Upload Path** - Define a path in FTP server to store video. For the path name, English Alphabets, numbers and special characters ( / ~ ! @ \$ ^ ( ) \_ - { } [ ] ; , ) can be used.
- 9 Click 'Save' to make above setting effective.

SAVE	Save FTP information
CANCEL	Click 'Cancel' to return to the previous setting.
CHECK	Check the F/W file and if the file exists, 'F/W Update' button will appear and click it to update for F/W.



# Setup - System Setup

## Date & Time Settings

---

The screenshot shows the 'DATE&TIME SETTINGS' interface. It is divided into three main sections: 'TimeZone Setup', 'Time Format', and 'Current Date & Time'. The 'TimeZone Setup' section has a dropdown menu for 'TimeZone' set to '(GMT-08) Pacific Time (US & Canada), Baja California' and an 'APPLY' button. The 'Time Format' section has a dropdown menu for 'Time Format' set to 'mm/dd/yy' and an 'APPLY' button. The 'Current Date & Time' section shows the current date and time as '07/12/2017 23:17:24'. Below this is the 'New Camera Date & Time' section, which has three radio button options: 'Synchronize with my computer' (selected), 'Setup manually', and 'Synchronize with time server (NTP)'. The 'Synchronize with my computer' option shows a date and time of '07/13/2017 15:17:01'. The 'Setup manually' option shows date and time fields set to '2005 01 01' and '00 00 00'. The 'Synchronize with time server (NTP)' option shows an 'NTP Server' dropdown set to 'pool.ntp.org'. There are three 'APPLY' buttons: one for 'TimeZone Setup', one for 'Time Format', and one for the entire 'Current Date & Time' section. Numbered callouts 1 through 7 point to these elements: 1 points to the 'TimeZone Setup' section, 2 to the 'Time Format' section, 3 to the 'Current Date & Time' section, 4 to the 'Synchronize with my computer' radio button, 5 to the 'Setup manually' radio button, 6 to the 'Synchronize with time server (NTP)' radio button, and 7 to the bottom 'APPLY' button.

- 1 TimeZone Setup** - Choose TimeZone for camera. It will be activated after clicking 'Apply' button.  
※ Prior to setting below 'New Camera Date & Time', set correct Timezone first.
- 2 Time Format** - Select the time format yy-mm-dd or mm/dd/yy.
- 3 Current Date & Time** - Shows the current date and time setting in the Camera.
- 4 Synchronize with my computer** - Set the date / time using those of PC currently connected.
- 5 Setup manually** - Set the date / time by typing manually.
- 6 Synchronize with time sever Time Zone (NTP)** - Choose time server available to connect to current camera. Date & Time will be updated automatically every hour when connected.
- 7** Click 'Apply' to make above setting effective.

# Setup - System Setup

## Users Management

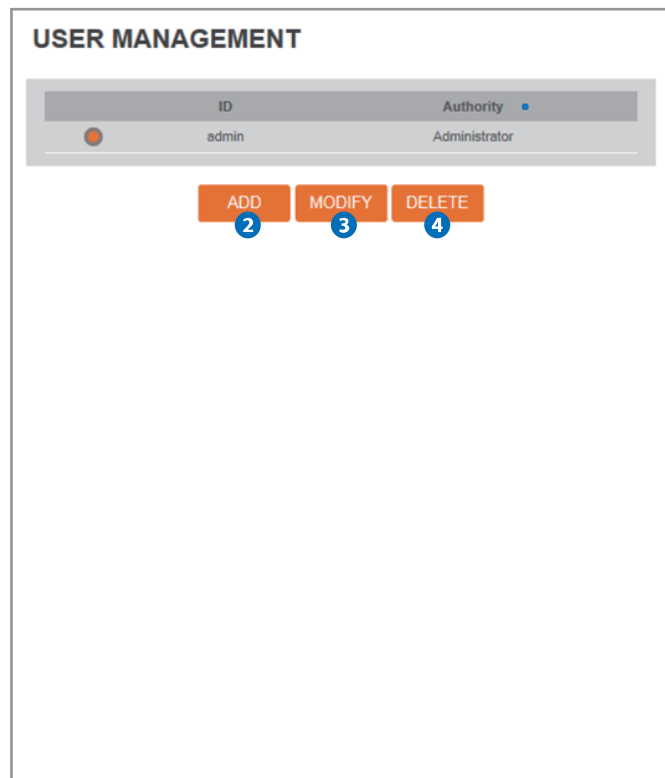

**1 Users** - List all the user accounts for authentication.

**2 Add** - Register a new user

ID	Enter a new user ID except Admin since it exists.
Password	Enter the user Password.
Verify	Enter the user Password again for verification.
User Authority	Select Operator or Viewer. Viewer : Only monitoring is allowed. Operator : Most of the functions are allowed except 'Setup'. Administrator : All functions are allowed.

⊗ The ID and Password are limited to 10 characters.

Click 'Apply' to make above setting effective.

⊗ Click 'Cancel' to return to the previous menu.

**3 Modify** - Modify the information of the user accounts registered. For admin account, only Password function can be modified.

**4 Delete** - Delete the selected user account. Admin account cannot be deleted.

# Setup - System Setup

## System Log

---

The screenshot displays the 'SYSTEM LOG' interface. At the top, there is a 'Filter' section with the following options:

- Date: 2016-04-22 ~ 2016-04-22
- Time: 0 0 0 ~ 0 0 0
- Type: All
- Sort: Decending

Below the filter section are two buttons: 'REFRESH' (highlighted with a blue circle 2) and 'FILTER' (highlighted with a blue circle 1). Below these buttons is a 'List' section containing a table of log entries (highlighted with a blue circle 3).

Date & Time	Log	IP
2005/01/01-00:07:14	Change video encoder config	192.168.1.39
2005/01/01-00:00:20	RTSP session connected	192.168.1.39
2005/01/01-00:00:19	RTSP session connected	192.168.1.39
2005/01/01-00:00:17	RTSP session connected	192.168.1.39
2005/01/01-00:00:15	Network initialized	system
2005/01/01-00:00:15	Sensor alarm accured : 1 : Off	system
2005/01/01-00:00:15	System initialized	system
2005/01/01-00:45:47	System terminated	system
2005/01/01-00:45:46	Factory default	192.168.1.39

At the bottom of the list, there are navigation arrows and a page indicator showing '1 2 3 4 5 6 7 8 9 10'.

1 **Filter** - Select a date, sort or type of log to filter the log.

2 Click the 'Refresh' button to refresh the log list.  
☒ Click 'Filter' to view the filtered log.

3 **System Log List** - The filtered log is displayed.

# Setup - System Setup

## Factory Reset

---

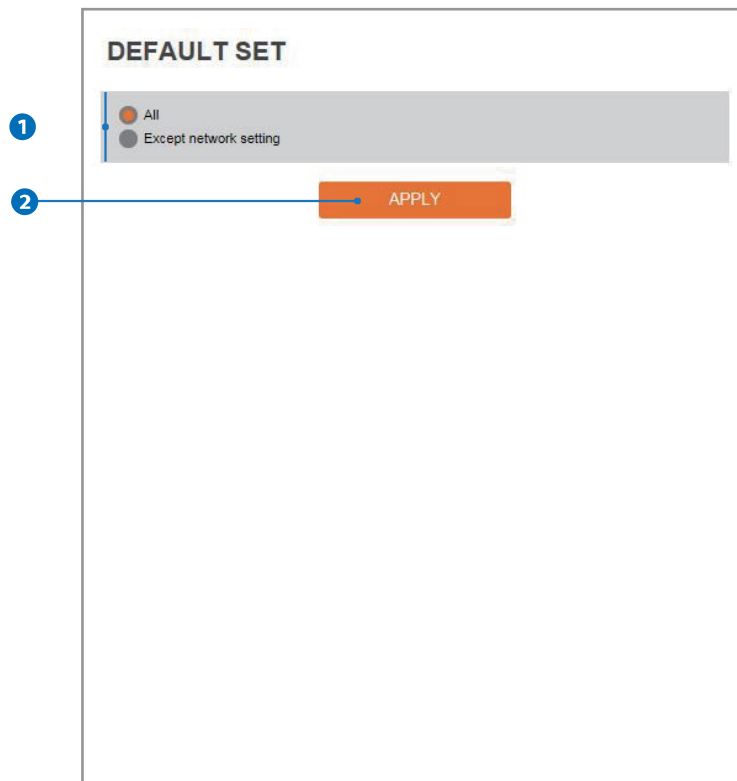

**1 Reset to the factory defaults** - Return the setup to the factory default.

**All** - Reset all Settings to the factory defaults.

---

**Except Network Settings** - Except Network related settings, reset all others to the factory default.

---

**2** Click 'Apply' to make above setting effective.

## Setup - System Setup

# Restart

---

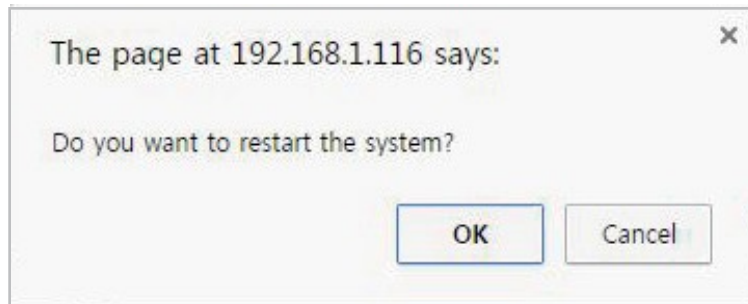

If you click the 'RESTART' menu, a message box will be shown to confirm. Click the 'OK' button to restart.

# Network Setup - Quick Start of Network Connection

---

## Please follow the steps below to complete the initial setup of the network function.

- i** Please do not power on the IP Camera until instructed.
- i** Temporarily disable any proxy servers configured in internet Explorer.
- i** If connecting the IP Camera directly to a modem, power down and reset the modem. Leave the modem powered down until configurations are finalized with the IP Camera and the IP Camera has been correctly connected to the modem.

1. Connect the IP Camera and PC to the configured network.
2. Open the IP Installer on a PC, then search for the IP camera.

- i** If you have a DHCP server, it will automatically set the Camera IP.
- i** If you do not have a DHCP server, Camera IP is set to 192.168.1.80 after one minute. In this case, PC IP must be changed to the IP to be able to access the 192.168.1.80.

3. If multiple numbers of camera are connected it should be distinguished by the mac address of the Camera.
4. Click the Camera IP, and connect to the WEBPAGE.
5. Default ID/Password to access IP Camera are both the word: admin.
6. Familiarize yourself with the Viewer Interface Screen.
7. please install VLC to display live video.
8. The IP setting can be set to 'STATIC' at IP Installer or web viewer followed by Setup -> Network -> Network Settings
9. If the IP Camera is connected to a network which utilizes a router, you must have Port Forwarding configured on your personal router to forward all ports to the IP address you have assigned the IP Camera.
10. After configuring Port Forwarding on your router (if necessary), you may access your IP Camera on your local network by opening Internet Explorer and specifying the IP address and Web Port that you have assigned to the IP Camera.

- i** Example: <http://192.168.0.200:8888>
- i** If you leave your Web Port set to 80, you don't need to specify the port in the Address Bar to access to your IP Camera.

## 11. Access your IP Camera via the Internet :

---

If you use a static IP address assigned by your ISP

- 1) Open Internet Explorer.
  - 2) Type the IP of the IP Camera.
  - 3) If you use a router, type the routers' static IP and the web port number of the IP Camera.
- 

If you have a dynamic address provided by your ISP

- 1) Open Internet Explorer and visit the DDNS website.
  - 2) Register the IP Camera.
  - 3) Reboot the IP Camera.
  - 4) Give the DDNS server 10 minutes to locate your IP Camera's IP information.
  - 5) Click the refresh button in the Internet Explore.
  - 6) After your camera is connected, select your camera.
-

# Network Setup - DDNS Registration

---

**If you have DYNAMIC IP service from your Internet Service Provider (ISP), you can't tell the current IP address of the IP Camera.**

**To solve this problem, you have to register to our DDNS service.**

**At first, you have to check if you are using dynamic addressing. If so, register your IP Video Server on our DDNS website before you configure, setup, or install the IP Camera.**

**Even though your IP is not dynamic, you will get benefit if you register to DDNS. In this case, just remember 'hostname.dyndns.com/gate1' instead of complicated series of numbers like <http://201.23.4.76:8078>.**

**For more details, contact our Support Center.**

☒ To use a public DDNS called 'dyndns' or 'no-ip', refer to the detail information on how to use the service.  
(Visit the web site : <http://www.dyndns.com> or <http://www.no-ip.com>)

# Network Setup - Guide to Network Environment

---

**Please configure the IP Camera at the installation site. You must determine your network scenario in order to configure the IP Camera with the proper TCP/IP settings. This tutorial will guide you through the process. Before actually configuring the IP Camera, determine settings to be applied. Record those settings to be used to configure your IP Camera for reference.**

**When configuring your IP Camera, treat the IP Camera as another PC on your network. You will assign it several addresses and other TCP/IP properties to match your current network.**

**This step-by-step tutorial will teach what IP addresses and network configurations should be assigned based on the network scenario.**

5. The following descriptions are several basic network scenarios. Determine which scenario describes your network. If your network does not match one of the scenarios below and you are unsure how to setup your IP Camera, contact your network administrator and then call our Support Center.

**i** You cannot control the rectangular gray areas and only the ISP has access to the devices.

1. Before you begin, locate any information and settings received from your Internet Service Provider (ISP). You may need to refer to these IP addresses at a later time during the configuration.

Current TCP/IP Settings	
IP Address	
Subnet Mask	
Default Gateway	
Primary DNS Server	
Secondary DNS Server (Option)	

Static     Dynamic

**i** If you were not given any IP addresses or the ISP was responsible for the setup and installation of your Internet connection, go to step 2.

**i** If you are not using a router on your network, your 'Current TCP/IP Settings' (from the previous section) and 'Assigned IP Addresses from My ISP' will be exactly the same.

2. You must determine whether the IP address is STATIC or DYNAMIC. At this moment, you are only concerned about the ISP. Did they provide you with a STATIC or DYNAMIC address? If you are unsure, contact your ISP.
3. Configure your IP Camera's TCP/IP settings for network connectivity by selecting Setup from the main interface and selecting TCP/IP located on the left of the Setup screen.
4. If prompted for ID and Password, use 'admin' for both entries.

The default web port number is 80. If port 80 is blocked by the ISP, a value between 1025 ~ 60000 should be used. If TCP port 80 is blocked, consult the ISP



# Network Setup - Setup Case A, B

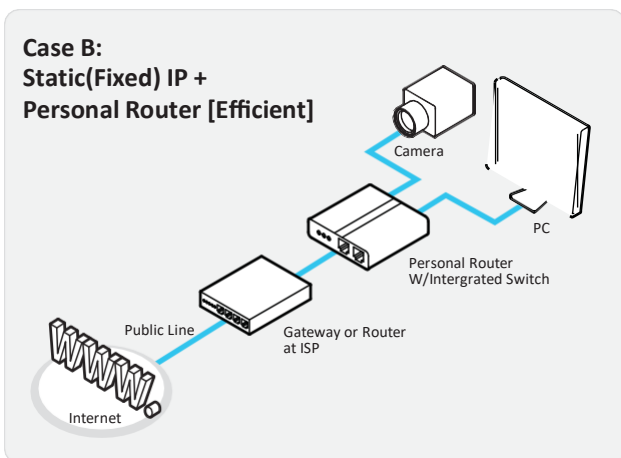
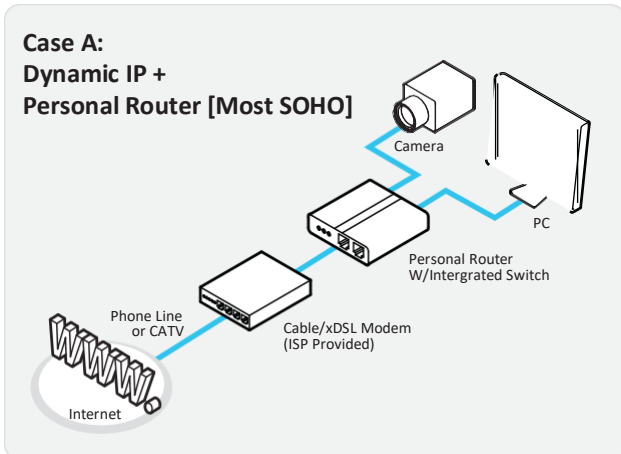

## Configure your IP Camera's TCP/IP properties as follows :

1. Network Type: STATIC (even though you have Dynamic IP from your ISP, use STATIC on the IP Camera)
2. Internet Address : A private IP address such as 192.168.0.200 (Example)

**i** You need to assign an IP address to the IP Camera just as you do with PC.

**i** The IP address you assign must be unique to your network and match your network as well. For information on how to choose a unique IP and match your network, read the FAQ.

**i** The IP address you assign must be a private IP. For information on how to choose a private IP please, read the FAQ.

3. Subnet Mask : 255.255.255.0 (Example)

**i** You must use the same subnet mask as the one you noted under 'Current TCP/IP Settings'.

4. Default Gateway : 192.168.0.1 (Example)

**i** This IP address must be the IP address of your router. (private or LAN side)

**i** Use the same Default Gateway you noted under 'Current TCP/IP Settings'.

5. Preferred DNS Server : Use the 1st DNS Server from 'Assigned IP Address from My ISP'.

**i** If you did not receive any IP addresses from your ISP, contact the ISP and acquire the IP address of their DNS server.

6. DDNS Server : Use the DDNS server.

**i** This is the same site you will register later to accommodate dynamic IP from your ISP.

7. Web Port : 8888

**i** Do not use the default port 80 as this number must be changed.

**i** You may select any number between 1025 ~ 60000.

# Network Setup - Setup Case C, D

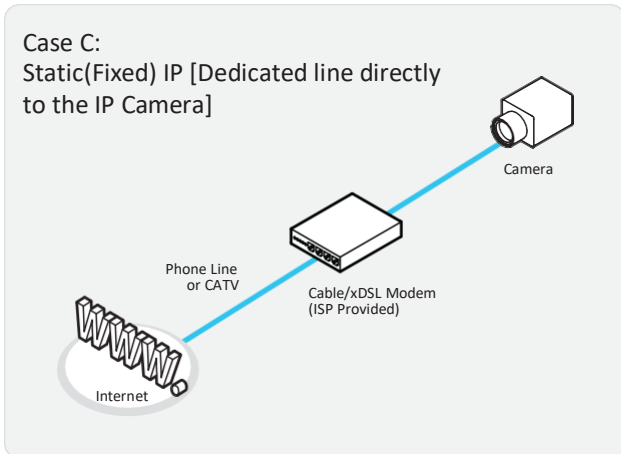

## Configure your IP Camera's TCP/IP properties as follows :

1. Network Type : STATIC
2. Internet Address : A static IP address received from your ISP such as 24.107.88.125 (Example)

**i** You need to assign an IP address to the IP Camera just as you do with PC.

3. Subnet Mask : Subnet mask assigned from your ISP such as 255.255.255.240 (Example)

4. Default Gateway : 24.107.88.113 (Example)

**i** Use the assigned default gateway from your ISP

5. Preferred DNS Server : Use the 1st DNS Server from 'Assigned IP Address from My ISP'

**i** If you have not received any IP addresses from your ISP, contact them to acquire the IP address of their DNS server.

6. DDNS Server : Use the DDNS server

**i** This is the same site you will register later to utilize our DDNS service.

7. Web Port : 80

**i** You may select any number between 1025 ~ 60000.

Case D:  
Dynamic IP + DSL/Cable Modem [Connected directly to the IP Camera]

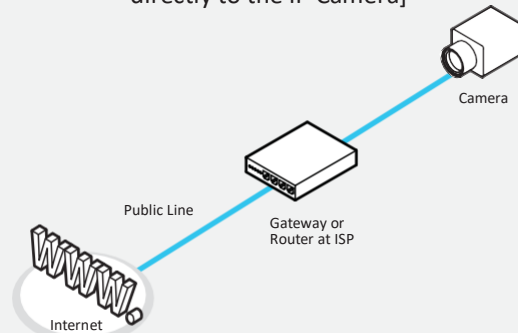

**i** To connect the IP Camera directly to a modem, power down and reset the modem. Leave the modem powered down until configurations are finalized with the IP Camera and the IP] Camera has been connected correctly to the modem. Then power on the modem, followed by the IP Camera.

## Configure your IP Camera's TCP/IP properties as follows :

1. Network Type: DYNAMIC
2. DDNS Server : Use the DDNS server

**i** This is the same site you will register later to accommodate dynamic IP from your ISP.

3. Web Port : 80

**i** You may select any number between 1025 ~ 60000.

# Network Setup - Port Forwarding

---

**After entering the correct TCP/IP settings, you are ready for 'Port Forwarding'(Cases A, B).**

1. Please record the TCP/IP settings of your IP Camera for future reference. You may need this information to access your IP Camera and to configure 'Port Forwarding'.

IP Camera TCP/IP Settings	
IP Address	
Subnet Mask	
Default Gateway	
Preferred DNS Server	
DDNS Server	
Web Port	

2. After clicking 'Apply', the system will prompt for reboot. Please allow the system 50 seconds to reboot and accept the changes. After 50 seconds, close the configuration screen. The view will display 'Trying to Reconnect'. If the ACTIVE light on the IP Camera has gone off and is now back on again flashing, the IP Camera has rebooted. After the system reboots completely, remove the power supply from the unit and close Internet Explorer.
3. Return your PC/Laptop TCP/IP properties to their original settings.
4. Before installing the IP Camera, you must use 'Port Forwarding' on your personal router (Cases A, B).

You will need to forward 1 ports:

- Web Port

All the ports will be forwarded to the IP address you assigned to the IP Camera.

In the example above, you would forward:

- 8888 > 192.168.0.200

**i** For information on how to use 'Port Forwarding', please read Appendix C.

# Network Setup - Starting IP Camera

---

**After forwarding correctly the Web Port, through your router (if applicable), install the IP Camera in a proper location.**

1. Locate the serial number located on the label attached to the bottom of the IP Camera, you will need this for DDNS registration.
2. Connect the IP Camera to your router or cable/DSL modem (per your network scenario) via a Cat5/5e UTP Ethernet network cable.
3. Supply power to the IP Camera.
4. After 1 minute, verify the IP Camera indicators:
  - LINK : Flickering/Solid
5. After configuring Port Forwarding on your computer (if necessary), access your IP Camera on your local network by opening Internet Explorer and specifying the IP address and Web Port assigned to the IP Camera.

**i** Examples: <http://192.168.0.200:8888> or <http://24.106.88.123>

**i** If you left your Web Port set to 80, do not need to specify the port in the Address Bar to access the IP Camera.

6. Access your IP Camera via the Internet :

---

If you use Case B, C

- 1) Open Internet Explorer.
- 2) Type the IP of the IP Camera.

---

If you use Case A, D

- 1) Open Internet Explorer.
  - 2) Visit the DDNS website.
  - 3) Register the IP Camera.
  - 4) Give the DDNS server 10 minutes (MAX) to locate your IP Camera's IP information. You may reboot the server to send an immediate request to our DDNS server.
  - 5) After your camera is connected, select your camera.
- 

**i** The difference between B and C is that B needs to set the port forwarding.

**i** Since the type of DDNS differs from the service type, refer to the related service site.

# Appendix - FAQ

---

## 1. My POWER light is not on?

Power is not being supplied to the unit. Please use the power supply shipped with the unit and verify that a power source is active from the attached power outlet used to connect the adapter. You can test this by plugging in any other electrical device and verify its operation. After using the power supply shipped with the product, checking the power source, and reinserting the power connector into the IP Camera, please call our Support Center. The power supply may be defective.

## 2. My ACTIVE light is not flashing?

Verify the power supply to the unit. Power off the unit and back on again, wait 1 minute, if the ACTIVE light still does not begin to flash, you will have to set the unit to its factory default (THIS WILL DELETE ANY CONFIGURATION AND SET THE UNIT TO THE FACTORY DEFAULTS). Power on the unit and insert the end of a paper clip into the small recessed opening on the back of the unit. Use the clip to press the button located within that opening.

## 3. My LINK light is not flashing or solid?

Verify the cable connection. 99% of the time the cable's connection to the unit is causing this problem. Try using a different network cable or crossover cable (for PC connection only). Try reinserting the cable, if this still doesn't solve the problem call our Support Center.

## 4. I can access the video server on my LAN, but not from the Internet.

Verify that your router (if applicable) has port forwarding properly configured. If accessing from our DDNS service, verify correct serial number. Firewall issues may prevent user access.

## 5. How do I open an MS-DOS or Command Prompt?

Start > (All) Programs > Accessories > Command Prompt

## 6. How do I find out my IP address information if my settings were automatically detected?

- 1) Open a Command Prompt
- 2) At the prompt type - "ipconfig / all" (without the quotes)
- 3) Near the end of the information supplied, should be your current IP address, subnet mask, default gateway and DNS servers

## 7. I can't connect!!

In the case of a connection failure.

Modem Reboot > Modem Reboot Finished > Router Reboot > Router Reboot Finished > IP Camera Reboot > IP Camera Reboot Finish > Verify DDNS and IP Camera connection, if applicable.

## 8. How do I "PING" an IP address?

- 1) Open an MS-DOS (or Command) prompt
- 2) At the prompt type - "ping xxx.xxx.xxx.xxx" (without the quotes and replace the "x"s with an IP address)
- 3) Press Enter

## 9. I'm accessing my video server remotely over the Internet and the video stream is choppy, is this normal?

Yes. The frames per second received remotely are determined by your bandwidth capabilities both at your site where the IP Camera is installed and your remote location. The lower of the two sites will determine how fast your video stream is received. It is recommended to have at least a 256Kb/sec upstream connection from the site where the IP Camera is installed. Lower speeds will operate properly, but provide poor remote performance. The Faster the Internet connection at both ends, the faster the video stream.

## 10. How do I enable or check VLC on my browser

---

### *Internet Explorer*

Open Internet Explorer > Tools on the menu bar > Internet Options > Security Tab > Custom Level > Scroll down and verify that you are prompted or have enabled plug-ins to be downloaded and executed. > click OK > restart browser.

---

### *Chrome*

Open Chrome > Chrome menu settings > Advanced settings > Individual information - content settings > Run automatically

---

## 11. How do I reset the unit to factory defaults?

Refer to the previous functions page and find the reset button. Power ON the unit and use a paper clip to push the reset button within that opening. You should then see the ACTIVE light turn on and after a few seconds the ACTIVE light will begin to flash, signifying a successful reboot. If the ACTIVE light does not turn on after depressing the reset button, please try holding the button in for a few seconds and releasing. **YOU WILL LOSE ALL DATA THAT HAD BEEN ENTERED PREVIOUSLY AND THE IP CAMERA WILL BE SET TO ITS FACTORY RESETS.**

# Specifications - Dimension

Unit: Inch (mm)

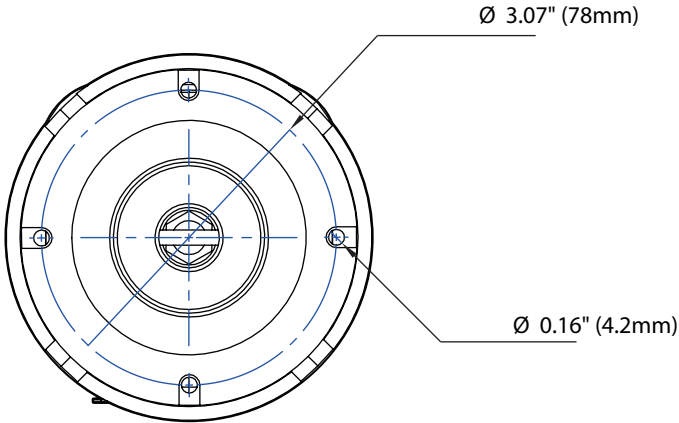
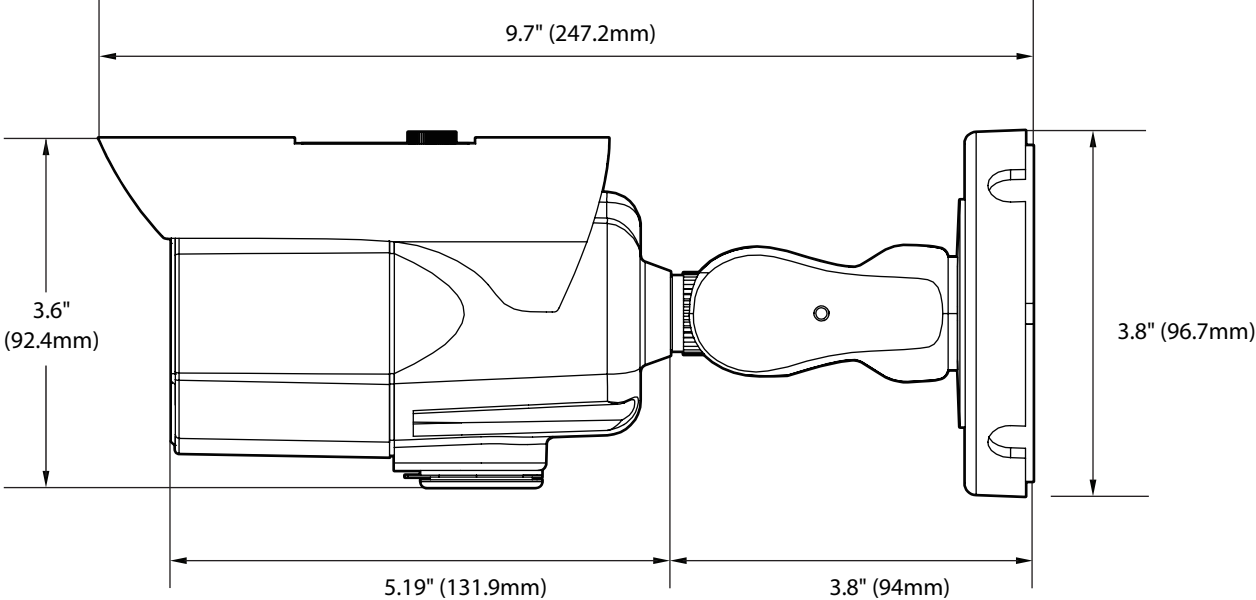

# Warranty Information

---

Go to <https://digital-watchdog.com/page/rma-landing-page/> to learn more about Digital Watchdog's warranty and RMA.

To obtain warranty or out of warranty service, please contact a technical support representative at: 1+ (866) 446-3595, Monday through Friday from 9:00 AM to 8:00 PM EST.

A purchase receipt or other proof of the date of the original purchase is required before warranty service is rendered. This warranty only covers failures due to defects in materials and workmanship which arise during normal use. This warranty does not cover damages that occurs in shipment or failures which are caused by products not supplied by the Warrantor or failures which result from accident, misuse, abuse, neglect, mishandling, misapplication, alteration, modification, faulty installation, setup adjustments, improper antenna, inadequate signal pickup, maladjustments of consumer controls, improper operation, power line surge, improper voltage supply, lightning damage, rental use of the product or service by anyone other than an authorized repair facility or damage that is attributable to acts of God.

# Limits & Exclusions

---

There are no express warranties except as listed above. The Warrantor will not be liable for incidental or consequential damages (including, without limitation, damage to recording media) resulting from the use of these products, or arising out of any breach of the warranty. All express and implied warranties, including the warranties of merchantability and fitness for particular purpose, are limited to the applicable warranty period set forth above.

Some states do not allow the exclusion or limitation of incidental or consequential damages or limitations on how long an implied warranty lasts, so the above exclusions or limitations may not apply to you. This warranty gives you specific legal rights, and you may also have other rights from vary from state to state.

If the problem is not handled to your satisfaction, then write to the following address:

Digital Watchdog, Inc.  
ATTN: RMA Department  
16220 Bloomfield Ave  
Cerritos, CA 90703

Service calls which do not involve defective materials or workmanship as determined by the Warrantor, in its sole discretion, are not covered. Cost of such service calls are the responsibility of the purchaser.





*Complete Surveillance Solutions*

DW® east coast office and warehouse: 5436 W Crenshaw St, Tampa, FL 33634

DW® west coast office and warehouse: 16220 Bloomfield Ave., Cerritos, California, USA 90703

PH: 866-446-3595 | FAX: 813-888-9262

[www.Digital-Watchdog.com](http://www.Digital-Watchdog.com)

[technicalsupport@dwcc.tv](mailto:technicalsupport@dwcc.tv)

Technical Support PH:

USA & Canada 1+ (866) 446-3595

International 1+ (813) 888-9555

French Canadian 1+ (904) 999-1309

Technical Support hours: Monday-Friday 9:00am to 8:00pm Eastern Standard Time